

# AXE-FX II



## Amp & Cab Quick Reference Guide for Axe-Edit

Amp and cab block parameters explained  
Amp and cab descriptions  
Amp speaker types matched with Axe-Fx cabs  
CC assignments sorted by function & CC  
Drive block descriptions  
Amp and cab block diagrams

content compiled from the Axe-Fx II manual, Wiki and forum suggestions, corrections, etc.: send a PM to JMA at the Fractal Audio forum

firmware v11.0 ~ Axe-Edit v3.0 ~ rev. August 30, 2013



## TOP ROW

**INPUT DRIVE (was DRIVE)** – In a typical amp this is called various names (Drive, Volume, Gain, etc). It is the knob closest to the input jack. In many cases it has a bright cap so the frequency response will be dependent on the knob position. As the gain increases the tone shifts from a treble and upper mid emphasis to bass and lower mid emphasis.

**OVERDRIVE** – A second drive control for some amp models. It does not have a bright cap so it only affects the gain. Set Overdrive to 8.00 to get the identical response to pre-v10.10 firmware for models that have Overdrive.

INPUT DRIVE and OVERDRIVE will have a dramatic effect on the response of the amplifier and the personality of your instrument.

See the footnote in the amp description list to quickly find the amps that have the OVERDRIVE control.

**BASS/MID/TREB** – “Passive” tone stack. Can be changed with TONESTACK TYPE.

In most cases, DRIVE, BASS, MID, and TREB are accurate within 10% of the actual amp.

For most tone stacks, when you set the BASS and TREB to zero, the tone stack becomes basically “flat” and the MID becomes a volume control.

**COMP** – Controls the amount of preamp compression and sets the compression threshold of the cathode follower. Same as the CATHODE THRESHOLD parameter, which is one of three settings that adjust the cathode follower algorithm. See the Dynamics page for more. Many models default to zero as they do not have measureable compression.

**PRESENCE** – Boosts/cuts upper frequencies from the power amp by varying negative feedback frequency response. Increased presence can help sound cut through a heavy mix. Decrease it to compensate for overly-bright amps. Presence is tightly coupled to speaker impedance (HI FREQ, HI RESONANCE).  
**HI CUT** – On amps with no negative feedback (DAMPING=0), PRESENCE is replaced with HI CUT, a simple high-shelf EQ at the power amp output.

**DEPTH** – Boosts low frequencies from the power amp by varying the negative feedback frequency response. On amps with a fixed depth circuit, Depth will have a preset value. Also called “Resonance” or “Girth” on some amps.

**MASTER VOL** – Determines the amount of power amp distortion. As it increases, the tone controls have less influence on the sound. Amp models default to a starting Master Volume setting when selected. (Non-MV amps default to 10.)

Before adjusting the MASTER VOL, be aware that it defaults to 10 for non-master volume (vintage) amps. If you want more MV on non-MV amps, increases the MV TRIM.

## BOTTOM ROW

**INPUT TRIM** – A clean, linear gain applied at the input to the amp block that adjusts the relative gain of the preamp. (This is analogous to changing the type of tube for V1 in an actual amp.) It does the same thing as the BOOST switch, the difference being that you can control how much is boosted or cut (+/-20 dB). As a rule of thumb, every 2x multiplier equals +6dB boost. In other words, Input Trim at 4.0 produces a +12dB boost. Input Trim should be set to 1.00 if you want to match the actual amp.

You can also adjust preamp gain globally with GLOBAL AMP GAIN, which affects every amp and preset. One reason you might do this is to compensate for the gain difference when switching to a hotter/quieter guitar.

On the Axe-Fx unit: GLOBAL button > CONFIG > AMP GAIN

**BOOST** – Toggles the input boost for an additional 12 dB of input gain. Enabling Boost sometimes works better than turning up preamp gain.

**CUT** – Reduces the amount of low frequencies into the amp. This can be used to achieve a tighter tone or to reduce low-end “flub”. This is similar to increasing LOW CUT (Tone page) while still retaining some low end so it doesn’t get thin. Provides an easy way to cut the overpowering bass in models such as Recto, Splawn Nitro, Komet and others.

**FAT** – Emphasizes midrange “body” by shifting down the tonestack center frequency. Specifically, it alters the tonestack treble capacitor, so the effect depends on the tonestack’s location (see TONE page).

**BRIGHT** – A “treble peaker” which functions mainly to compensate for the loss of highs at low amp volume. The effect may be subtle or quite pronounced, depending on the amp selected, and it is also affected by the BRIGHT CAP.

**SATURATION** – Switches in a zener diode clipping stage between the preamp and the tone stack (the “Arrendondo Mod”) for more aggressive distortion character which also adds compression and cuts volume. You may have to adjust the MASTER or LEVEL to compensate.

**DYNAMIC PRESENCE** – Models the output transformer leakage inductance that results in a brightening of the tone when the power amp is pushed. Increasing this value results in a brighter response as the virtual power amp is pushed. When playing softly or at lower gains, the influence of this control is lessened. Note that this only affects the power amp modeling and is dependent on the degree of power amp overdrive. This control can also be set negative to cause the tone to darken when playing hard. This control can also be used to help “dial in” the sweet spot of an amp model. As the MV is increased an amp becomes more liquid, compressed and easier to play. However, the highs may get overly compressed causing the amp to sound too dark. The Dynamic Presence control allows you to get the desired power amp drive and liquid feeling and then bring the highs back without affecting the rest of the spectrum.

**DYNAMIC DEPTH** – Analogous to the Dynamic Presence control, this increases or decreases low frequencies when the virtual amp is being pushed. While real amps don’t display this behavior, it is a valuable tone-shaping tool.

**MASTER VOL TRIM** – Can be used to increase (or decrease) the Master Volume for non-MV amps. If MV is 10 and you set MV Trim to 2.0 then the MV will be 10.



#### TOP ROW

**LOW RES FREQ/RES Q/RESONANCE** – Guitar loudspeakers have a low-frequency resonance, typically about 100 Hz. This shifts up slightly when the speaker is mounted in an enclosure and is typically lower for open back cabs. This resonance causes an increase in the power amplifier response due to the finite output impedance of the power amp. The default LF Resonance is based on the cab most likely to be used with that amp.

**HI FREQ** – Sets the “corner frequency” of the speaker impedance rise due to voice-coil inductance. The speaker voice-coil presents an inductive load to the power amp at high frequencies. This inductive load, in conjunction with the output transformer capacitance, creates a high-frequency resonance. Typical guitar speakers have a corner frequency between 1 kHz and 2 kHz. Lower values give more midrange emphasis.

**HI RESONANCE** – Similar to HI FREQ but this control only changes the slope of the resonance. Default value is consistent with typical “semi-inductance” of speaker voice-coil. Varying this value will change the high-frequency load presented to the power tubes.

#### BOTTOM ROW

**XFORMER LOW/HIGH FREQ** – These set the output transformer bandwidth. **SPEAKER DRIVE** – Simulates distortion caused by pushing a speaker too far. It interacts with the MASTER.

**NOTE:** The SPEAKER page is not an EQ. It allows you to adjust the impedance that the virtual speaker presents to the virtual power tubes. In most cases, the resulting EQ is quite different than the impedance curve since negative feedback flattens the response. If you turn DAMPING all the way down then the EQ will be close to the impedance curve (but still influenced by the transformer).

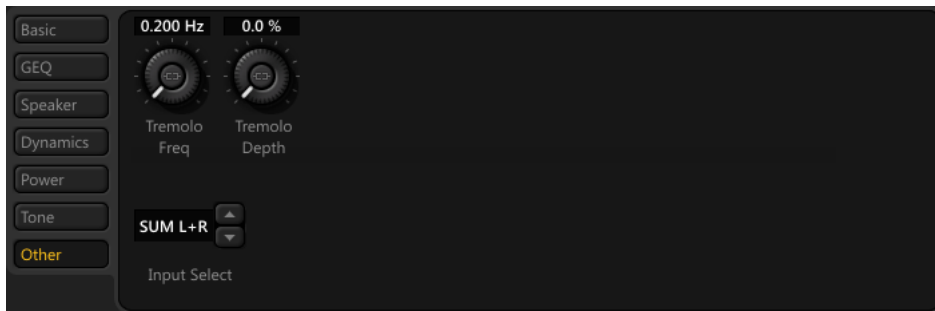

#### TOP ROW

**TREMOLO FREQ/DEPTH (bias tremolo)** – Works by varying the bias of the virtual power tubes, resulting in a particularly “organic” sound. Most importantly, the tremolo is “self-ducking” and decreases at higher signal amplitudes. On some amps high values of bias trem depth can result in excessive crossover distortion. On others, the tremolo can vary greatly between loud and soft playing.

#### BOTTOM ROW

**INPUT SELECT** – The Amp block processes audio in mono. This control determines how incoming stereo signals will be processed.



### TOP ROW

**SUPPLY SAG** – Controls power supply impedance. Higher settings simulate higher power supply impedance, causing greater tube plate voltage (B+) “droop” and giving a more compressed, spongy and looser feel. Sag interacts with the MASTER: as the power amp is pushed and draws more current from its power supply, Sag has more effect. Sag values around 2 simulate a solid-state rectifier, 4-6 a tube rectifier.

Setting SUPPLY SAG to 0 disables the power amp and turns the MASTER into a simple level control with a 40 dB range.

**DYNAMICS** – Simulates the interaction and compressive effects of the power amp, power supply and speaker when they are pushed hard. Negative values cause dynamic range expansion, while positive values cause dynamic range reduction, resulting in a more compressive, bouncier effect.

In general, the more heavily driven the power amp section is, the more effect the SUPPLY SAG and DYNAMICS controls have.

**PICK ATTACK** – Controls a sophisticated dynamic range processor that operates on leading edge transients. Negative values reduce pick attack while positive values enhance it.

**THUNK** – Allows adding “weight” to tones by simulating the very low-frequency interaction of a speaker cabinet with the guitar. Higher values simulate closer proximity of the guitar to the cabinet.

**XFORMER MATCH** – One of the most powerful controls in the amp block. It changes the turns ratio (and therefore the primary impedance) of the output transformer, which controls how easily power tubes are driven into clipping. Decreasing causes the power tubes to clip later, the phase inverter and grid clipping become more predominant, and the speaker resonance will be more pronounced. This control has more influence with higher MASTER values and low gain amps and less influence with highly compressed amps. Increase MASTER until desired amount of power amp distortion is achieved, then adjust XFormer Match for sound’s character: higher = more compressed, lower = more open. The LF/HF RESONANCE parameters interact strongly with this parameter.

The cathode follower algorithm has three adjustable parameters:

**CATHODE THRESHOLD** – Same as the COMP parameter. Sets the compression threshold of the cathode follower. Higher value give more compression.

**CATHODE TIME** – Sets the attack time of the compressor.

**CATHODE RATIO** – Sets the maximum amount of compression, with lower values giving more compression.

### BOTTOM ROW

**B+ TIME CONSTANT** – Associated with SUPPLY SAG. Controls rate of change in power tube plate supply. “B+” refers to one of the high voltage “taps” or outputs of the main power transformer. Lower values give a bouncier feel, while higher values give a tighter, more aggressive feel. The effect of lower B+ is equivalent to increasing XFORMER MATCH. A lower B+ means the plates clip sooner which is the same as increasing the turns ratio on the transformer. This is assuming that you rebias since typically lower the B+ affects the bias.

**DYNAMICS TIME** – Controls how fast DYNAMICS happens.

**BIAS EXCURSION** – GRID MODELING parameter that controls how much the power tube grid voltage droops when the grids conduct.

**EXCURSION/RECOVERY TIME** – GRID MODELING parameter that controls the time constants associated with BIAS EXCURSION.

**XFORMER DRIVE** – Sets the amount of core saturation in the output transformer, controlling how hard the transformer is driven. Higher values simulate a smaller, more easily saturated transformer.

**PREAMP BIAS** – Controls the bias point of the last triode (cathode follower not counted) in the preamp. Depending on the bias points of the previous stages increasing or decreasing this value can alter both the harmonic content and the attack characteristics. Typically, if the previous stage has a negative bias then increasing this value will be more noticeable and vice-versa.

Ghost notes are the result of a 120Hz signal plus harmonics getting past the power supply filtering. High SUPPLY SAG along with low B+ TIME CONSTANT can cause “ghost notes” when POWER SUPPLY TYPE is AC (as in a real amp). Lower B+ Time Constant values will make the amp feel “faster” but too low can cause ghost notes.

To hear what ghosts notes sound like, try the following: take an amp like Plexi 100W, turn the SAG up and the B+ TIME CONSTANT down, then play single notes around the 5th fret on the G string. You should hear a tone unrelated to the pitched note.



### TOP ROW

**PRESENCE FREQ** – Alters the center frequency of the amp’s PRESENCE control.

**DEPTH FREQ** – Alters the center frequency of the amp’s DEPTH control.

**GRID MODELING** – Replicates grid conduction in the preamp and power amp stages, which adds “real world” high frequency “fizz” or “grit”. Turn it off if this effect is undesirable. Grid modeling parameters include BIAS EXCURSION and EXCURSION/RECOVERY TIME.

**POWER TUBE TYPE** – Allows selecting Tetrode (i.e. 6L6, KT66, etc.) or Pentode (i.e. EL34, 6BQ5, etc.) power tube types. The type defaults to the appropriate value when a model is chosen but may be overridden by the user.

**POWER TUBE BIAS** – Sets the bias point of the power amp. Increase Power Tube Bias to decrease crossover distortion and vice-versa. Lower values approach pure Class-B operation. Higher values approach pure Class-A.

**DAMPING** – Controls the amount of negative feedback in the power amp. The feedback decreases output impedance, causing the amp to react less to the speakers (“damping”). Higher values give a brighter, tighter, punchier sound but can be harsh at very high MASTER levels. Lower values give a smoother, loose and gritty sound and feel.

Setting **DAMPING** to 0 disables negative feedback and replaces the **PRESENCE** control with **HI CUT**. **DEPTH** is also disabled since it only affects negative feedback.

**POWER TYPE** – When set to AC, models AC rectification and resulting supply ripple. High SUPPLY SAG along with low B+ TIME CONSTANT can cause “ghost notes” when the supply type is AC (as in a real amp). Lower B+ Time Constant values will make the amp feel “faster” but too low can cause ghost notes.

**AC LINE FREQ** – Selects the line frequency.

### BOTTOM ROW

**TRIODE1/2 PLATE FREQ** – Sets the cutoff frequency of the plate impedance for the next-to-last (triode 1) and last (triode 2) triode in the chain, which allows you to control the buzziness that sometimes occurs with higher gain settings. The capacitor across the triode’s plate resistor is used to smooth the response and reduce noise. You can adjust the amount of capacitance, and the resulting frequency. Lowering the frequencies dials out sharpness and “fizz”, making the tone smoother.

**TRIODE HARDNESS** – Controls how sharply the triodes enter saturation and can be used to simulate softer/harder tubes. The effect is subtle and most apparent at edge of breakup. Lower values give softer saturation, higher values give a more aggressive breakup. Defaults to an appropriate value when an amp model is selected.

**MV LOCATION** – Location of the Master Volume.

PRE-PI – Before the phaser inverter (most amps).

POST-PI – After the phase inverter (AC types).

PRE-TRIODE – Amp types based on Hiwatt models.

**POWER AMP LOW/HI CUT** – Low/high pass filters placed after the power amp section that shape the tonal color of the power amp. Note that AMP VOICING also sets these values. Reduce Hi Cut to remove unwanted “fizz”.



## TOP ROW

**LOW CUT FREQ** – Reduces the amount of low frequency (10-1000Hz) before the preamp input. Use this is to tighten up a tubby bass end. Somewhere between 10-150Hz is generally where it will sound best for standard guitar tones. Also see CUT (Basic page).

**HIGH CUT FREQ** – Reduces the amount of high frequency (2k-20kHz) after the preamp output. Lower the value to make your top end sound smooth and silky, raise it to make it brilliant and defined.

**DEFINITION** – A basic “tilt EQ” located at the amp input. It changes the fundamental character of the amp from vintage to modern or vice-versa. Positive values increase the amount of upper overtone saturation, negative values reinforce lower harmonics.

**CHARACTER/FREQ** – These two parameters control powerful “inverse homomorphic filters”. When playing softly this dynamic filter has little effect on the sound. As the amount of distortion increases, the influence of the filter increases. The Character Frequency control sets the center frequency of the filter while the Character control sets how pronounced the effect is. For example, to darken the tone when playing harder, one might set the frequency to 10 kHz and the amount to -5. Setting the amount to +5 will make the tone brighter when playing hard. (Default = 0.)

**BRIGHT CAP** – Sets the value of the capacitor which determines the sonic effect of the BRIGHT switch. Increase to make the preamp brighter and vice-versa.

**AMP VOICING** – Voices the amp to a variety of tonal styles. Choose “Neutral” for the raw amp sound or one of the other voicings for a quick “mix-ready” tone. Affects POWER AMP LOW/HI CUT values and applies some parametric EQ.

## BOTTOM ROW

### TONESTACK TYPE

**ACTIVE** – Gives each tone control  $\pm 12$  dB boost/cut making them more sensitive; they also will not interact with each other.

**DEFAULT** – Matches the tonestack with the selected amp type.

**[AMP]** – Replaces the default tonestack with one from another amp.

**TONE FREQ** – Sets the center frequency of the tone controls. This control works whether you are using PASSIVE, ACTIVE, or substitute tone stacks.

### TONE LOCATION

**PRE** – Places the tone stack at the input to the preamp.

**POST** – Places it between the preamp and power amp.

**MID** – Places it between the last two triode stages.

**END** – Places it after the power amp (which is impossible with a real amp).

The farther upstream you position the stack, the thinner the sound.

MID will sound chunkiest, with END being rather dark.

**USE MIMIC** – Identifies deviations in the response of the simulated amplifier to the actual amplifier and generates corrective data bringing a level of accuracy that has been heretofore unachievable.

When an amp is selected, the settings on this page are updated accordingly. If you then select a different tone stack, the settings remain unchanged.

For a flat tone stack, set the TONESTACK TYPE to Vintage with B/M/T at noon. This will allow the flexibility of being able to boost or cut bass and treble.

## TONESTACK TYPES

BROWNFACE (Vibroverb)*	VINTAGE	SHIVER CLN	HOT KITTY
BLACKFACE (Twin Reverb)*	CA3+SE	CAMERON	VIBRATO-KING
BASSGUY	FREYER D60	BRIT JVM OD1	GIBTONE SCOUT
TOP BOOST	MR Z 38 SR	BRIT JVM OD2	CA3+SE CLEAN
PLEXI	EURO UBER	5153 GREEN	BF FIXED MID
BOUTIQUE	PVH 6160	5153 BLUE	GERMAN V4
HI POWER	SOLO 100	5153 RED	VIBRATO-LUX
USA NORMAL	CORNCOB	BRIT SUPER	DIRTY SHIRLEY
USA FAT	XTC (Bogner)	DIV13 CJ	PLEXI 100W
RECTO ORG	CAROLANN	BADGER 18	ROCKET
RECTO RED	CITRUS	ATOMICA	CONCOURSE
SKYLINE (Dumble)	BRIT JM45	SPAWN	TRIPTIK LD
GERMAN	USA RHY	BADGER 30	TRIPTIK CLN
JR BLUES	RECTO NEW ORG	BRIT SILVER	
WRECKER	RECTO NEW RED	SUPER VERB	

\* Generally, Blackface amps are cleaner with scooped mids. Brownface amps have more mids and fall in between Blackface (cleaner) and Tweed (dirtier).



#### TOP ROW

**CAB** – Loads a cabinet impulse response (IR). The older FAS and RW cabs were recorded with neutral mics. OH, Kalthallen, and the Mix/Producer Pack series have matching mics included in the IR.

**SPEAKER SIZE (MONO CAB ONLY)** – “Scales” the IR to simulate shrinking or enlarging of the speaker. This effect can be used to shift where the tone sits in a mix, or to create dramatic effects. Subtle settings (0.9-1.1) will sound most natural.

**MOTOR DRIVE** – Models the effect of high power levels on speaker tone. Simulates the impedance and distortion effects that occur when the speaker is pushed hard. Be aware this setting adds a little compression as you increase it. **NOTE:** This parameter appears on the ROOM page for stereo cabs.

#### BOTTOM ROW

**MIC** – Don’t feel that you have to add a mic unless you *want* to add EQ, which is basically what you would be doing.

**LOW/HIGH CUT** – Adjusts the cutoff point of first order low/high pass filters. Increase the Low Cut if the sound is too “bassy” or “boomy.” Decrease the High Cut for a darker cab tone. Common settings are 80-150 Hz for high pass, and 5-7 kHz for low pass.

**PROXIMITY** – Causes an increase in bass or low frequency response as proximity is increased (closer to speaker). Disabled when MIC is set to none.

**PROXIMITY FREQ** – This allows tuning the frequency range over which the proximity effect occurs. **NOTE:** This parameter appears on the ROOM page for stereo cabs.

**DELAY** – Delays the signal up to 1 second. With cab in stereo mode or with two cab blocks in parallel, delaying one cab relative to the other can achieve interesting comb filter effects. A common practice in studio recording is to use multiple mics on a speaker at different distances to intentionally introduce it. The effect is most pronounced when the cabs are summed to mono.



#### TOP ROW

**ROOM LEVEL/SIZE** – Determines the level and size of room reverb that is built into the cab block. Increase to add room ambience to the sound.

**MIC SPACING** – Increases delay times inside the room reverb by simulating the distance of the room microphone from the sound source.

**AIR** - Mixes some of the signal going into the Cab block with the signal leaving the Cab block.

**AIR FREQUENCY** – Sets the cutoff frequency of the mixed signal. Increase to maximum value for a straight mix.

#### MIC TYPES

57 DYN – Shure SM57  
 58 DYN – Shure SM58  
 421 DYN – Sennheiser MD 421 II  
 87A COND – Shure Beta 87A  
 U87 COND – Neumann U87  
 E609 DYN – Sennheiser e609 Silver  
 RE16 DYN – Electro-Voice RE16  
 R121 COND – Royer Labs R-121  
 D112 DYN – AKG D112  
 67 COND – Neumann U67

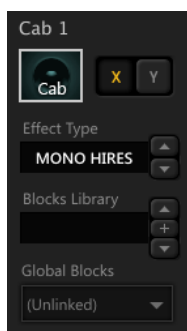

#### EFFECT TYPE

**MONO HIRES** – mono processing at 2048 resolution (42ms).  
**MONO LORES** – mono processing at 1024 resolution (21ms).  
**STEREO** – stereo processing at low resolution (2 × 1024).

Note that with the stock cabs there is no significant energy beyond an IR length of 1024. (The high res of 2048 allows for 1024 in stereo.) A mono cab with a non-acoustic IR would typically use Mono Lores (which also uses less CPU).

**LINK (STEREO ONLY)** – Sets the left channel parameters as master controls, which set identical values for left and right. You can still set right channel values independently.

## FACTORY CABINETS

1	1x6 Oval	39	4x12 1960B T75 (RW)	77	1x10 Prince Tone Black Mix	115	1x12 Nuclear Tone Mix
2	1x8 Tweed	40	4x12 1960B K120 (RW)	78	1x10 Prince Tone Silver Mix	116	1x12 Scumtone 25W Mix
3	1x10 Gold	41	4x12 1960B V30 (RW)	79	1x12 Junior Blues Mix	117	2x12 Boutique Mix
4	1x10 Blue	42	4x12 Hi-Power (RW)	80	1x12 Deluxe Verb Mix	118	2x12 SV Legend Mix
5	1x12 Tweed	43	4x12 Recto V30 (RW)	81	1x12 Deluxe Tweed Mix	119	1x12 E12L (V9)
6	1x12 Black	44	4x12 Recto V30 (OH)	82	1x12 Vibrato Lux Mix	120	1x12 Brit G12H30 (V9)
7	1x12 Blue	45	4x12 Solo V12 (RW)	83	1x12 Class-A 15w Blue Mix	121	2x12 Doubleverb D120 (V9)
8	1x12 E12L (RW)	46	4x12 Solo S12X (RW)	84	1x12 Division 13 Mix	122	2x12 Doubleverb C12N (V9)
9	1x12 Studio	47	4x12 German V30 (RW)	85	1x12 Hot Kitty Mix	123	2x15 Doubleshow (V9)
10	1x12 EMI Open Back (JM)	48	4x12 German Boutique (RW)	86	1x12 Hawaii Mix	124	4x12 Basketweave G12H30 (V9)
11	1x12 Boogafunk Blue (OH)	49	4x12 PVH6160 (RW)	87	1x15 Tweed Pro Mix	125	4x12 1960B V30 (V9)
12	1x12 Boogafunk E12L (OH)	50	4x12 Uber T75 (RW)	88	1x15 Empire Mix	126	4x12 Recto V30 (V9)
13	1x12 Tweed Blue (RW)	51	4x12 Uber V30 (RW)	89	2x10 Super Tweed Mix	127	4x12 German V30 (V9)
14	1x12 Tweed Deluxe (RW)	52	4x12 Uber T75+V30 (RW)	90	2x10 Vibrato Lux Mix	128	4x12 PVH6160 (V9)
15	1x12 Brit Blue (RW)	53	4x12 Citrus V30 (RW)	91	2x12 Double Verb Mix	129	4x12 Uber T75 (V9)
16	1x12 Brit G12H30 (RW)	54	4x12 Mills 12K (OH)	92	2x12 Pro Verb Mix	130	4x12 Uber V30 (V9)
17	1x15 Blues	55	4x12 SLM Blue (OH)	93	2x12 Class-A 30w Blue Mix	131	4x12 Uber T75+V30 (V9)
18	1x15 Thunderbolt (RW)	56	4x12 SLM G65 (OH)	94	2x12 Class-A 30w Silver Mix	132	4x12 Citrus V30 (V9)
19	2x12 Black	57	4x12 SLM H75 (OH)	95	2x12 Supremo Mix		
20	2x12 Brit	58	4x12 SLM M75 (OH)	96	2x12 Santiago EJ1250 Mix		
21	2x12 Doubleverb D120 (RW)	59	4x12 SLM V30 (OH)	97	2x12 Santiago Altec Mix		
22	2x12 Doubleverb C12N (RW)	60	4x12 20w	98	3x10 Vibrato King Mix		
23	2x12 Blue	61	4x12 25w	99	4x10 Bassguy Mix		
24	2x12 Top Boost Blue (RW)	62	4x12 V30	100	4x10 Super Verb Mix		
25	2x12 Top Boost Silver (RW)	63	4x12 German	101	4x12 Basketweave Green Mix		
26	2x12 Boutique (RW)	64	4x12 30w (Ultra)	102	4x12 Basketweave AX Mix		
27	2x12 Jazz (RW)	65	4x12 Cali	103	4x12 Basketweave TV Mix		
28	2x12 Gold 30 Far-Field (JM)	66	1x15 L.A. Bass	104	4x12 Cali Lead 80s Mix		
29	2x12 G12-65 Far-Field (JM)	67	4x10 Aluminum Bass (RW)	105	4x12 Rumble EV12L Mix		
30	2x12 Boutique	68	8x10 SV Bass (RW)	106	4x12 Rumble EV12S Mix		
31	2x12 Doubleshow (RW)	69	4x12 V30 #1 (Kalthallen)	107	4x12 PVH6160 Mix		
32	4x10 Tweed Bass	70	4x12 V30 #2 (Kalthallen)	108	4x12 Petrucci V30 Mix		
33	4x10 Bassguy P10 (RW)	71	4x12 V30 #3 (Kalthallen)	109	1x15 SV Bass M88 Mix		
34	4x12 Basketweave G12H30 (RW)	72	4x12 V30 #4 (Kalthallen)	110	1x15 SV Bass Subkick Mix		
35	4x12 Basketweave G12L (RW)	73	4x12 G12T75 #1 (Kalthallen)	111	4x10 SV Bass M88 Mix		
36	4x12 Basketweave G12M20 (RW)	74	4x12 G12T75 #2 (Kalthallen)	112	4x10 SV Bass Subkick Mix		
37	4x12 Basketweave G12M25 (RW)	75	1x8 Champlier Mix	113	4x10+Tweeter SV Bass M88 Mix		
38	4x12 1960A G12M (RW)	76	1x8 Vibrato Champlier Mix	114	1x12 Class-A 20 Dlx Mix		

Blue and red indicate multiple firmware versions of the same cab. Magenta cabs are far field IRs.













<u>AXE-FX AMP</u>	<u>BASED ON</u>	<u>DESCRIPTION</u>
1987x Normal	Marshall 1987x Vintage Series	Features an "essential" mod to the tonestack of this Plexi. Reissue of the 50w JMP Lead 1987.
1987x Treble	Marshall 1987x Vintage Series	Treble channel of the 1987x Vintage Series Plexi.
5153 Blue	EVH 5150 III (Blue)	Blue (rhythm) channel of the 100w 6L6 model, made in collaboration with Fender. <a href="#">Recommended settings.</a>
5153 Green	EVH 5150 III (Green)	Green (clean) channel.
5153 Red	EVH 5150 III (Red)	Red (high gain/lead) channel.
59 Bassguy	Fender Bassman	1959, Tweed era, 5F6-A circuit. Low-to-medium gain amp designed for bass but widely adopted by guitarists.
65 Bassguy	Fender Bassman	1965 Blackface version, AB165 circuit which is very crunchy and bright and does not sound like a typical Fender.
AC-20 Dlx Bass	Morgan AC20 Deluxe	EL84. Normal/Brilliant switch = Normal. Bright OFF + treble booster = Brian May, Bright ON = U2.
AC-20 Dlx Treb	Morgan AC20 Deluxe	Normal/Brilliant switch = Brilliant.
Atomica High	Cameron Atomica	A "brown sound" 100w amp, high gain channel.
Atomica Low	Cameron Atomica	Low gain channel.
Band Commander	Fender Bandmaster	1968 Silverface Fender Bandmaster with the AB763 circuit.
Big Hair	80's metal	Mids without mud. Revive the 80s metal scene. (Spandex not included.)
Blanknshp Leeds	Blankenship Leeds 21	EL84 tubes. Boutique version of an 18w Marshall with a big sound at low power. Mercury Magnetics transformers.
Bludojai Clean	Bludotone Ojai (Clean)	Reported to be an exact clone of Robben Ford's Tan Dumble. Clean mode modeled with preamp boost (PAB) engaged as the owner prefers this. To disengage PAB change the tonestack type to Skyline.
Bludojai Lead	Bludotone Ojai (Lead)	Lead mode.
Boutique 1	Matchless Chieftain	Medium-gain amp, thick, yet crisp, with a fair amount of power amp breakup. Based on a Vox circuit.
Boutique 2	Matchless Chieftain	Added Boost for more gain and high-frequency emphasis.
Brit 800	Marshall JCM800	Model 2204. Bring the Master up for true 80's tone. To soften the attack, lower Triode Freq and increase Damping.
Brit 800 MOD	modded Marshall JCM800	Removed the treble peaker, making the amp "heavier" and "less strident".
Brit Brown	Van Halen's Marshall.	Faithful recreation of the legendary "Brown Sound" – The modded "#1" Marshall.
Brit JM45	Marshall JTM45 (Ch 1)	Made famous by Clapton and others; a modified Bassman design. Try with a Tonebender or Treble Booster.
Brit JM45 Jump	Marshall JTM45 (Ch 1)	Emulates "jumpering the inputs" on a 4-hole amp.
Brit JVM OD1 GN	Marshall JVM410 (OD1, Green)	OD1 channel, Green mode, hot-rodded.
Brit JVM OD1 OR	Marshall JVM410 (OD1, Orange)	OD1 channel, Orange mode, extra gain. For Red mode, enable Boost or increase the Input Trim parameter.
Brit JVM OD2 GN	Marshall JVM410 (OD2, Green)	OD2 channel, Green mode, lower mids than OD1.
Brit JVM OD2 OR	Marshall JVM410 (OD2, Orange)	OD2 channel, Orange mode, more gain and lower mids than OD1. See above for Red mode.
Brit Pre	Marshall JMP-1	Rack-mount preamplifier version of the Brit 800. OD2 channel. Crunchy "ZZ" tone.
Brit Silver	Marshall Silver Jubilee	100w Marshall Silver Jubilee (2555), commemorative "25/50" model. Slightly darker and higher gain than JCM800.
Brit Super	Marshall AFD100	100w dual-mode head with 6550 tubes, believed to be a modified 1959 Tremolo. Used by Slash on "Appetite for Destruction". AFD mode adds an extra gain stage, 34 mode is based on Slash's modded JCM 800 (2203).
Buttery	Budda Twinmaster	Based loosely on a late 90's specimen. Relies mostly on power amp distortion.
CA3+ Clean	CAE 3+ SE preamp (Ch 1)	Custom Audio Electronics preamp. The Clean channel is based on a Blackface Fender preamp.
CA3+ Lead	CAE 3+ SE preamp (Ch 3)	Channel 3 (Lead).
CA3+ Rhy	CAE 3+ SE preamp (Ch 2)	Channel 2 (Rhythm).
Cali Leggy	Carvin Legacy VL100	Legacy 1, 100w, EL34. Uses a "James" tone stack which is more like hi-fi tone controls. Based on Steve Vai's original signature Legacy amplifier. To get a Steve Vai tone, keep Treble low, Bass high and not too much Gain.
Cameron Ch 1	Cameron CCV100 (Ch 1)	An amp its creator Mark Cameron calls "one pissed off amp"
Cameron Ch 2	Cameron CCV100 (Ch 2)	Higher gain tone. On Channel 2, Saturation is engaged by default, no Presence (set it to 0).
Carolann OD-2	Carol-Ann OD-2r	50W, EL34 or 6L6 tubes. Overdrive channel. Model fine-tuned by the highly respected Alan Phillips.
Citrus RV50	Orange Rockerverb	"Dirty" channel of the 50w head known for warmth and rich harmonics.
Class-A 15w TB	Vox AC-15 Top Boost	15w, EL84 tubes. The heart of this amp's tone comes from its power section and no negative feedback.

Red amps are non-MV (no Master Volume on the real amp). The MASTER VOL is set to 10 by default.

⚡ Includes the additional OVERDRIVE control.

🌀 The actual amp has a control labeled "Tone" which corresponds to TREB on the Axe-Fx. For a more realistic simulation, leave BASS and MID at noon.

🔊 Amps with no negative feedback, created by setting DAMPING to 0. PRESENCE is replaced with HI CUT. DEPTH is also disabled since it only affects negative feedback.

<u>AXE-FX AMP</u>	<u>BASED ON</u>	<u>DESCRIPTION</u>
Class-A 30w 	Vox AC-30	30w, EL84 tubes. Combo that dominated the British Invasion. Gritty character, warm tone, great feel. For authentic tone, leave the tone controls at noon and use Hi-Cut to cut treble
Class-A 30w TB 	Vox AC-30 Top Boost	30w, EL84 tubes. Created in response to demand for "more treble". Great highs and slightly reduced bass.
Comet 60	Komet 60	
Comet Concourse	Komet Concorde	EL34 tubes. Similar to Trainwreck amp. Response switch = "Fast". To replicate "Slow" reduce INPUT TRIM to 0.25"
Corncob M50 	Cornford MK50 II	Boutique British amp. Plexi-meets-modern tone with big cojones.
Das Metall	Diezel VH4 (Ch 4)	EL34 or 6L6 tubes. High-gain, boutique amp famous for its powerful, heavy, aggressive sound. See <i>Dizzy V4 4</i> .
Deluxe Tweed  	Fender Tweed Deluxe	Fender Deluxe (5E3) from the 50's, 15w. The earliest and most popular of the so-called Tweed amplifiers.
Deluxe Verb	Fender Deluxe Reverb	1965 Blackface, 22w, AB763 circuit. Great, chimey tone with nice power amp breakup.
Dirty Shirley	Friedman Dirty Shirley	40w, 6L6. Designed to be an ultra-fat, sweet-sounding, classic rock amp. Based on a JTM45.
Division13 CJ 	Divided by 13 CJ11	11w, bassy amp, works best with single coils. High-performing "Tweed" meets "EL34" meets "Master Vol" 1x12.
Dizzy V4 2	Diezel VH4 (Ch 2)	High-gain boutique amp with heavy, aggressive sound. 6550, EL34 or 6L6. Channel 2, "gritty funk, dynamic clean."
Dizzy V4 3	Diezel VH4 (Ch 3)	Channel 3, the favorite channel for most users, with higher gain but still big dynamic range.
Dizzy V4 4	Diezel VH4 (Ch 4)	Channel 4, newer version of <i>Das Metall</i> . A monster of gain which still has great definition and authority.
Double Verb	Fender Twin Reverb	100w, 1966 Blackface, AB763 circuit. Known for amazing clean sounds and nice breakup.
Energyball	ENGL Powerball	100w Lead channel, 6L6 tubes. Very high-gain German model. Lots of bass. Great for aggressive, drop-tuned riffs.
Euro Blue	Bogner Ecstasy (Blue)	20th Anniv. model. Dark amp, turn up Presence or engage Bright. Blue channel, Structure switch = 'V' (Vintage).
Euro Blue Mdrn	Bogner Ecstasy (Blue)	Blue channel, Structure switch = 'M' (Modern).
Euro Red	Bogner Ecstasy (Red)	Red channel, Structure switch = 'V' (Vintage).
Euro Red Mdrn	Bogner Ecstasy (Red)	Red channel, Structure switch = 'M' (Modern).
Euro Uber	Bogner Überschall	120w, EL34. High Gain channel. Heavy grinding lows and insane gain. Sweep Presence for a wide variety of tones.
FAS 6160	Peavey EVH 5150	Alternative version of the PVH 6160, more open and less fizzy than the original amp. Also, a virtual choke has replaced the resistor found on the original's power supply filter. This results in a bouncier feel.
FAS Brown	Van Halen's Marshall	Original BROWN model from the Axe-Fx Standard/Ultra.
FAS Crunch	ultimate British amp	More dynamic and open than a Plexi, but with more gain.
FAS Lead 1	Mesa Boogie TriAxis (presumed)	Neutral high-gain lead with a tight midrange.
FAS Lead 2	Mesa Boogie TriAxis (presumed)	Hot-rodged British lead sound with a tonestack by Bob Bradshaw (Custom Audio Electronics).
FAS Modern	high gain rhythm + lead hybrid	High-gain hybrid. Equally well-suited to modern rhythm or lead work. Loosely based on a Recto with tighter bass.
FAS Modern II	high gain rhythm + lead hybrid	Tighter version of the popular FAS Modern model with a 5150-style bass boost in the tone stack.
FAS Rhythm	British + USA crunch	Combines the best features of the British and USA crunch models.
FAS Wreck	Trainwreck Express	Original WRECKER 1 model from the Axe-Fx Ultra.
Fox ODS I 	Fuchs Overdrive Supreme-50	Overdrive channel, 50w, 6L6 tubes. Mid switch ON.
Fox ODS II 	Fuchs Overdrive Supreme-50	Mid switch OFF.
Friedman BE	Friedman Brown Eye	50w or 100w, EL34. What many call "the ultimate modded Plexi" by Dave Friedman (Rack Systems).
Friedman HBE	Friedman Hairy Brown Eye	BE amp's alternate voicing with a gain boost. A killer hi-gain tone in your arsenal.
Fryette D60 L 	Fryette D60 (Less)	60w, KT88 or 6550 tubes. "Deliverance Sixty". "Less" mode.
Fryette D60 M 	Fryette D60 (More)	"More" mode.
Gibtone Scout 	Gibson Scout	1964 GA17RVT Scout, 17w, vintage clean tones. No tone controls on the real amp.
Herbie Ch2+	Diezel Herbert (Ch 2+)	3-channel 180w, called "looser" and "more "familiar" than the VH4. Channel 2+ gets you into Diezel VH4 territory.
Herbie Ch2-	Diezel Herbert (Ch 2-)	Set Ch 2- at 35% gain for a cranked Plexi tone, 60% for a JCM800 tone.
Herbie Ch3	Diezel Herbert (Ch 3)	Channel 3.
Hipower Brillnt	Hiwatt DR103 (Brilliant)	1974 Harry Joyce/Hylight model. Medium-gain, full sound with unique tone-stack and chimey, grinding tone.
Hipower Jumped	Hiwatt DR103 (Normal/Brilliant)	Emulates "jumpering the inputs" on a 4-hole amp.

Red amps are non-MV (no Master Volume on the real amp). The MASTER VOL is set to 10 by default.

 Includes the additional OVERDRIVE control.

 The actual amp has a control labeled "Tone" which corresponds to TREB on the Axe-Fx. For a more realistic simulation, leave BASS and MID at noon.

 Amps with no negative feedback, created by setting DAMPING to 0. PRESENCE is replaced with HI CUT. DEPTH is also disabled since it only affects negative feedback.

<u>AXE-FX AMP</u>	<u>BASED ON</u>	<u>DESCRIPTION</u>
Hipower Normal	Hiwatt DR103 (Normal)	Normal channel.
Hot Kitty ☞	Bad Cat Hot Cat 30r (Ch 2)	30w, EL34, cathode bias, Channel 2. Voted by Guitar Player as “the second best combo of all time.”
Jazz 120	Roland JC-120	120w (stereo: 2x 60w). The only solid-state-based model in the collection, a quintessential clean tone.
JR Blues	Fender Blues Jr.	15w. A gutsy little classic with dual EL84s. To get the tone of an Egnater Rebel 20, set the Damping to 0.
Mr Z 38 Sr ☞	Dr. Z Maz 38 SR	38w, EL84 tubes. Popular with country and roots players. The quintessential country amp.
<b>Nuclear-Tone</b> ☞☞	<b>Swart Atomic Space Tone</b>	20w, 6V6. As with the actual amp, the bias tremolo is particularly effective.
ODS-100 Clean	Dumble OD Special (Clean)	100w “HRM” (Hot Rod Marshall) version, Clean channel. A coveted but rare amp made famous by Robben Ford.
ODS-100 LD Mid †	Dumble OD Special (OD)	Lead channel with the “Mid” switch engaged (this switch is sometimes labeled “Deep”).
ODS-100 Lead †	Dumble OD Special (OD)	Lead channel matched with the preamp bypass (PAB) engaged (which bypasses the input tone stack) and the Drive control at approximately 7.0. Played by the great Larry Carlton and many others!
<b>Plexi 100w High</b>	<b>Marshall Super Lead 1959</b>	1969 model. Classic amp head that gave rise to “the stack.” Great for crunchy rhythm work. As with the real amp, don’t be afraid to turn the bass all the way down or the treble all the way up, or it’s too flubby. Treble channel.
<b>Plexi 100w Jump</b>	<b>Marshall Super Lead 1959</b>	Emulates “jumping the inputs” on a 4-hole amp.
<b>Plexi 100w Nrml</b>	<b>Marshall Super Lead 1959</b>	Normal channel.
<b>Plexi 50w High</b>	<b>Marshall Super Lead 1959</b>	Treble channel.
<b>Plexi 50w Jump</b>	<b>Marshall Super Lead 1959</b>	Emulates “jumping the inputs” on a 4-hole amp.
<b>Plexi 50w Nrml</b>	<b>Marshall Super Lead 1959</b>	Normal channel.
<b>Prince Tone NR</b> ☞	<b>Fender Princeton (no reverb)</b>	Class A, 5w. 5F2-A, AA964 circuits. Modeled after early CBS “Silverface” model, pre-CBS design and components.
<b>Prince Tone Rev</b> ☞	<b>Fender Princeton (‘66 Reverb)</b>	Same as above. ‘66 Reverb edition.
<b>Prince Tone Twd</b> ☞	<b>Fender Princeton (Tweed)</b>	Same as above. Tweed version.
PVH 6160 Block	Peavey EVH 5150 (Lead)	120w, 6L6. Rematched against an original block letter Peavey EVH 5150. Lead channel.
PVH 6160 II	Peavey 6505+	120w, 6L6. Identical to the EVH II.
Recto Org Mdrn ☞	Mesa Boogie Dual Rectifier	Based on a 2-channel and a late 3-channel model, a high-gain masterpiece with crushing power and tightness. Rectos are bassy, fizzy beasts but that tone works great for certain genres. Modern mode, no negative feedback, more aggressive, be careful with the Master Volume. Orange channel.
Recto Org Vntg	Mesa Boogie Dual Rectifier	Vintage mode, Orange channel.
Recto Red Mdrn ☞	Mesa Boogie Dual Rectifier	Modern mode, Red channel.
Recto Red Vntg	Mesa Boogie Dual Rectifier	Vintage mode, Red channel.
<b>Ruby Rocket</b> ☞	<b>Paul Ruby Rocket</b>	Trainwreck Rocket clone (similar to a Vox).
Shiver Cln	Bogner Shiva (Clean)	90w, KT88. 20th anniv. Clean channel, powerful shimmering cleans. Dark amp, turn up Presence or engage Bright.
Shiver Ld	Bogner Shiva (Lead)	Lead channel, sweet, rich-sounding amp with aggressive, English-style midrange punch.
Solo 100 Clean	Soldano SLO-100 (Nrml/Clean)	SLO = Super Lead Overdrive, 100w. Normal channel, Clean gain selector.
Solo 100 Lead	Soldano SLO-100 (Lead)	Snarling Lead channel. The SLO -100 likes to be run hard, so the Master Volume defaults to a higher setting than on most other amps. To achieve the best sound, also back off the preamp gain.
Solo 100 Rhy	Soldano SLO-100 (Nrml/Crunch)	Normal channel, Crunch gain selector. Aggressive rhythm.
Solo 88 Rhythm	Soldano X88R preamp (Crunch)	Crunch channel of the Soldano X88R 3-channel preamp.
Solo 99 Clean	Soldano X99 preamp (Clean)	Soldano/Caswell midi-motorized X99 preamp; Clean channel.
Solo 99 Lead	Soldano X99 preamp (Lead)	Lead channel.
Spawn Nitrous	Splawn Nitro (OD)	100w, KT-88, OD channel. Splawn tone with more saturation and voiced for a bigger low end and low mids.
Spawn Q-Rod 1st	Splawn Quick Rod (1st gear)	100w, Ch 2. Signature Splawn tone with lots of bite, strong mids and 3 gear versatility. 1st gear, “Hot Rod Plexi”.
Spawn Q-Rod 2nd	Splawn Quick Rod (2nd gear)	2nd gear, “Hot Rod JCM 800”.
Spawn Q-Rod 3rd	Splawn Quick Rod (3rd gear)	3rd gear, “Super Hot Rod 800”.
Suhr Badger 18 ☞	Suhr Badger 18w	18w version of this EL84-powered tube rectifier classic. Master Volume is VERY powerful at altering the tone.

**Red amps are non-MV (no Master Volume on the real amp). The MASTER VOL is set to 10 by default.**

† Includes the additional OVERDRIVE control.

☞ The actual amp has a control labeled “Tone” which corresponds to TREB on the Axe-Fx. For a more realistic simulation, leave BASS and MID at noon.

☞ Amps with no negative feedback, created by setting DAMPING to 0. PRESENCE is replaced with HI CUT. DEPTH is also disabled since it only affects negative feedback.

<u>AXE-FX AMP</u>	<u>BASED ON</u>	<u>DESCRIPTION</u>
Suhr Badger 30 ☞	Suhr Badger 30w	In comparison to the 18w, the 30w features a solid state rectifier.
Super Verb.	Fender Super Reverb	Pre-CBS 1964 Blackface version of this 40w amp, AB763 circuit, Vibrato channel.
Supertweed	Fender Tweed series	Original SUPERTWEED model from the Axe-Fx Ultra. "Like a vintage Tweed amplifier on steroids."
Supremo Trem ☉ ☞	Supro 1964T	Supro 1964T.
SV Bass	Ampeg SVT	300w, Super Vacuum Tube bass amp. Used for decades by famous bassists the world over.
Thordendal Mdrn ☞	n/a	Based on Fredrik Thordendal's specifications.
Thordendal Vint.	n/a	Based on Fredrik Thordendal's specifications.
Trip-Tik Classic ☞	Carol-Ann Triptik (Classic)	50w, EL34. Classic channel: A little less gain and low end. Produces 70's and 80's British rock tones with a very wide and complex sound stage with no buzz or brittle high frequencies.
Trip-Tik Clean	Carol-Ann Triptik (Clean)	Clean channel.
Trip-Tik Modern ☞	Carol-Ann Triptik (Modern)	Modern channel: More gain and low end for those more modern heavy rhythm, dropped tunings. Also makes for a superb liquid lead channel with incredible sustain and harmonic bloom.
Tube Pre ☞	generic tube preamp	Completely neutral, low-gain tube preamp useful for "warming up" various sources.
Two Stone J-35 ☞	Two-Rock Jet 35	35w, 6L6. Lead mode with Bypass engaged, which bypasses the input tone stack for a more focused lead sound.
TX Star Lead	Mesa Lone Star (Lead)	50/100w, 6L6, Lead channel.
USA Clean 1	Mesa Boogie MKIV (Rhy 1)	Somewhat neutral, clean-sounding model that can pushed into warm clipping. Rhythm 1 channel.
USA Clean 2	Mesa Boogie TriAxis preamp	Rhythm Green channel ("Vintage Fat Rhythm" or "old Black Face").
USA IIC+ Bright ☞	Mesa B. Mark IIC+ (Lead)	Bright ON.
USA IIC+ Norm ☞	Mesa B. Mark IIC+ (Lead)	US-made amp famous for its smooth overdrive sound; Bright OFF.
USA Lead ☞	Mesa Boogie MKIV (Lead)	Tight, focused, hi-gain sound. Great for fusion and rock leads. Bright OFF, Mid Gain OFF.
USA Lead + ☞	Mesa Boogie MKIV (Lead)	Bright OFF, Mid Gain ON.
USA Lead BRT ☞	Mesa Boogie MKIV (Lead)	Bright ON, Mid Gain OFF.
USA Lead BRT + ☞	Mesa Boogie MKIV (Lead)	Bright ON, Mid Gain ON.
USA Pre Green ☞	Mesa Boogie TriAxis preamp	Lead 2 Green mode, medium gain Boogie lead. Modeled with the Hi-Cut control at maximum. Power amp sim active by default (Supply Sag nonzero).
USA Pre Yellow ☞	Mesa Boogie TriAxis preamp	Same as above. Lead 2 Yellow mode, classic Boogie lead (Mark IIC+/Mark IV).
USA Rhythm	Mesa Boogie MKIV (Rhy 2)	THE California crunch rhythm sound. Rhythm Channel 2 with Fat switch OFF.
Vibrato Lux	Fender VibroLux Reverb	1963 Blackface model, 6L6.
Vibrato Verb	Fender Vibroverb	40w combo that's great for clear or grinding cleans and gutsy blues. 6G16 circuit, Brownface era.
Vibrato-King ☞	Fender Vibro-King	Fender Vibro-King, famous for crystal cleans and powerful overdrive. Modeled with the Fat switch ON.
Wrecker 1	Trainwreck Express	Trainwreck Express, designed and built by the late, great Ken Fischer.

Red amps are non-MV (no Master Volume on the real amp). The MASTER VOL is set to 10 by default.

☞ Includes the additional OVERDRIVE control.

☉ The actual amp has a control labeled "Tone" which corresponds to TREB on the Axe-Fx. For a more realistic simulation, leave BASS and MID at noon.

☞ Amps with no negative feedback, created by setting DAMPING to 0. PRESENCE is replaced with HI CUT. DEPTH is also disabled since it only affects negative feedback.

<u>AXE-FX CAB</u>	<u>DESCRIPTION</u>
1	1x6 Oval .....6" Supro, 6x9 oval speaker used in some early amps (Supro). Combine with a Plexi for some Zep.
2	1x8 Tweed .....1x8 Fender Blues Jr. Really thin and cutting for roots blues leads.
3	1x10 Gold .....1x10 Chicago Jensen C10N
4	1x10 Blue .....1x10 Alnico Blue
5	1x12 Tweed .....Fender 1x12 Tweed, based on the original 12" speaker used in an early Fender "Tweed".
6	1x12 Black .....Fender Blackface 1x12
7	1x12 Blue .....Vox 1x12
8	<a href="#">1x12 E12L (RW)</a> .....200w Electro-Voice EVM-12L, housed in a solid mahogany, open-backed cabinet. <a href="#">Firmware 9 version at cabinet 119.</a>
9	1x12 Studio .....Mesa Studio 22 1x12
10	1x12 EMI Open Back (JM) .....Far field IR (Eminence).
11	1x12 Boogafunk Blue (OH) .....Boogafunk Thiele 1x12 with Celestion Alnico Blue.
12	1x12 Boogafunk E12L (OH) .....Boogafunk Thiele 1x12 with Electro Voice EVM-12L Classic.
13	1x12 Tweed Blue (RW) .....Tweed Deluxe narrow panel from 1956 with replacement Celestion Alnico Blue speaker for brighter tone with more high end sparkle.
14	1x12 Tweed Deluxe (RW) .....Tweed Deluxe narrow panel from 1956 with the original Jensen P12R speaker for the purists. Rounder, warmer sound than the Blue.
15	1x12 Brit Blue (RW) .....Celestion Alnico Blue 12", IR of the speaker without a cabinet.
16	<a href="#">1x12 Brit G12H30 (RW)</a> .....Celestion G12H30", IR of the speaker without a cabinet. <a href="#">Firmware 9 version at cabinet 120.</a>
17	1x15 Blues .....Peavey Delta Blues 1x15
18	1x15 Thunderbolt (RW) .....Supro Thunderbolt S6420 cabinet with the original 15" Jensen speaker. Probably a Red Wirez IR. Decent low end for a small, open-backed cabinet, a boost around 550Hz that gives it some mid range "honk", and crunchy upper mids.
19	2x12 Black .....Fender Deluxe/Twin Reverb 2x12
20	2x12 Brit. ....Vox AC30 with 2x12 Alnico Blue speakers.
21	<a href="#">2x12 Doubleverb D120 (RW)</a> .....67 Fender Twin Reverb cabinet with vintage JBL D120Fs. The D120s have more low end than the C12Ns and a peak around 3700 Hz, for distinctly edgier upper mids. <a href="#">Firmware 9 version at cabinet 121.</a>
22	<a href="#">2x12 Doubleverb C12N (RW)</a> .....67 Fender Twin Reverb cabinet with vintage Jensen C12Ns. A little less bass than the D120s and a peak around 2500Hz which gives it a crunchier sound than the JBLs. <a href="#">Firmware 9 version at cabinet 122.</a>
23	2x12 Blue .....Chicago Jensen P12Q, two classic American 12" speakers with blue labels.
24	2x12 Top Boost Blue (RW) .....Vox AC30 with two Vox labeled Celestion Alnico Blues made in the UK. Chimey Vox goodness.
25	2x12 Top Boost Silver (RW) .....Vox AC30 with two Vox labeled alnico, silver speakers. These are 25 wattish, T1656 frame, Alnico silvers with Pulsonic cones made for the Thomas Organ Company in the 60's. Slightly less extended upper mids than the blues, same cones as the early greenbacks. Cool speakers in pristine condition.
26	2x12 Boutique (RW) .....Matchless ES212, with one custom voiced 30w Celestion G12H and one 25w Celestion G12M.
27	2x12 Jazz (RW) .....Roland Jazz Chorus JC-120 with Roland 12" speakers. Clean, kinda like a more scooped JBL D120.
28	2x12 Gold 30 Far-Field (JM) .....Far field IR of a Celestion Alnico Gold.
29	2x12 G12-65 Far-Field (JM) .....Far field IR of a Celestion G12-65.
30	2x12 Boutique .....Matchless 2x12
31	<a href="#">2x12 Doubleshow (RW)</a> .....Fender Dual Showman cabinet with vintage JBL D130s. <a href="#">Firmware 9 version at cabinet 123.</a>
32	4x10 Tweed Bass .....Fender 4x10 Bassman
33	4x10 Bassguy P10 (RW) .....Reproduction Narrow Panel Tweed Bassman cabinet with vintage '57 Jensen P10Qs. Crunchy upper mids, scooped low mids, and tons of low end below 70Hz.
34	<a href="#">4x12 Basketweave G12H30 (RW)</a> ...68 Marshall Basketweave 4x12 with a matched quad of vintage, 30w, Celestion G12H "blackbacks." T1281 frames and "444", 55Hz bass cones from the late 70's. Unleash your inner Jimi, or Jimmy, if you prefer. <a href="#">Firmware 9 version at cabinet 124.</a>
35	4x12 Basketweave G12L (RW) .....68 Marshall Basketweave 4x12 with vintage Celestion G12Ls.
36	4x12 Basketweave G12M20 (RW) ..68 Marshall Basketweave 4x12 with 20w Celestion Heritage G12Ms. Brown sound all around.
37	4x12 Basketweave G12M25 (RW) ..68 Marshall Basketweave 4x12 with vintage Marshall labeled 25w Celestion G12Ms. These beauties have T1221 frames and Pulsonic 003 "lead" cones.
38	4x12 1960A G12M (RW) .....Slant Marshall 1960 with four 25w Celestion G12Ms, aka "Greenbacks".

In Firmware 10 many of the factory cabs were remixed so as to sound more "in the room". The (V9) cabs have a more "studio-polished sound". Far field IRs: cabs 10, 28 and 29.

<u>AXE-FX CAB</u>	<u>DESCRIPTION</u>
39	4x12 1960B T75 (RW) .....Straight Marshall 1960 with four Celestion G12T 75s.
40	4x12 1960B K120 (RW) .....Marshall 1960 cabinet with JBL K120s.
41	<a href="#">4x12 1960B V30 (RW)</a> .....Straight Marshall 1960 with four Celestion Vintage 30s. <a href="#">Firmware 9 version at cabinet 125.</a>
42	4x12 Hi-Power (RW) .....1975 Hiwatt SE4123 cabinet with four vintage 50w Fane purplebacks.
43	<a href="#">4x12 Recto V30 (RW)</a> .....Oversized Mesa Rectifier cabinet with four Celestion Vintage 30s. <a href="#">Firmware 9 version at cabinet 126.</a>
44	4x12 Recto V30 (OH) .....Mesa Boogie Rectifier 4x12 with Celestion Vintage 30s.
45	4x12 Solo V12 (RW) .....Soldano 412B with four Eminence Legend V12s. A lot more high end than the S12X version. It's a front-loaded cab with lots of resonance so you may need to back the mics off a bit more than usual.
46	4x12 Solo S12X (RW) .....Soldano 412B with four Eminence made S12Xs. S12Xs were stock in the older cabs. Give this one a little more distance than you might normally, the cab resonance is pronounced up close and the speakers have a notch in the upper mids between 4-8KHz. Nice for taming fizzy guitars.
47	<a href="#">4x12 German V30 (RW)</a> .....Bogner or ENGL Pro 4x12 cabinet with four Celestion Vintage 30s. <a href="#">Firmware 9 version at cabinet 127.</a>
48	4x12 German Boutique (RW) .....ENGL Pro 4x12 cabinet with four Celestion Vintage 30s.
49	<a href="#">4x12 PVH6160 (RW)</a> .....Older model Peavey 5150 4x12 cabinet with four Sheffield 1200 speakers. <a href="#">Firmware 9 version at cabinet 128.</a>
50	<a href="#">4x12 Uber T75 (RW)</a> .....Bogner Uberkab, with Celestion G12T 75s + Vintage 30s. This IR features the T-75s. <a href="#">Firmware 9 version at cabinet 129.</a>
51	<a href="#">4x12 Uber V30 (RW)</a> .....Same as above. This IR features the V30s. <a href="#">Firmware 9 version at cabinet 130.</a>
52	<a href="#">4x12 Uber T75+V30 (RW)</a> .....Same as above. This IR is a 50/50 mix of both speakers. <a href="#">Firmware 9 version at cabinet 131.</a>
53	<a href="#">4x12 Citrus V30 (RW)</a> .....Straight Orange 4x12 (PPC412) with Celestion Vintage 30s. <a href="#">Firmware 9 version at cabinet 132.</a>
54	4x12 Mills 12K (OH) .....Mills Acoustics Afterburner 4x12 with Celestion G12K-100 speakers.
55	4x12 SLM Blue (OH) .....SLM Electronics 4x12 with Celestion Alnico Blue speakers.
56	4x12 SLM G65 (OH) .....SLM Electronics 4x12 with Celestion Heritage G12-65 speakers.
57	4x12 SLM H75 (OH) .....SLM Electronics 4x12 with Scumback H75 speakers, similar to G12.
58	4x12 SLM M75 (OH) .....SLM Electronics 4x12 with Scumback M75 speakers, similar to 1987 G12M (greenback).
59	4x12 SLM V30 (OH) .....SLM Electronics 4x12 with Celestion Vintage 30 speakers.
60	4x12 20w .....Marshall with 4x12 low power 20w Greenbacks.
61	4x12 25w .....Marshall with 4x12 25w Greenbacks, 1970's.
62	4x12 V30 .....Generic 4x12 with Celestion V30 speakers.
63	4x12 German .....Bogner 4x12
64	4x12 30w (Ultra) .....G12H30 from the Axe-Fx Ultra (previously in this slot: 4x12 Metal, an Engl 4x12 captured by Jocke Skog of the band Clawfinger).
65	4x12 Cali .....Mesa Boogie traditional 4x12
66	1x15 L.A. Bass .....SWR 1x15 bass amp cabinet
67	4x10 Aluminum Bass (RW) .....Hartke 4x10" bass cabinet with aluminum drivers.
68	8x10 SV Bass (RW) .....Ampeg SVT 810 Bass cab with stock SVT 10" speakers.
69	4x12 V30 #1 (Kalthallen) .....4x12 with Celestion V30 speakers.
70	4x12 V30 #2 (Kalthallen) .....4x12 with Celestion V30 speakers.
71	4x12 V30 #3 (Kalthallen) .....4x12 with Celestion V30 speakers.
72	4x12 V30 #4 (Kalthallen) .....4x12 with Celestion V30 speakers.
73	4x12 G12T75 #1 (Kalthallen) .....4x12 with Celestion G12T75 speakers.
74	4x12 G12T75 #2 (Kalthallen) .....4x12 with Celestion G12T75 speakers.
75	1x8 Champier Mix .....Fender Champ with 8" speaker (Producer Pack).
76	1x8 Vibrato Champier Mix .....Fender Vibro Champ with 8" speaker (Producer Pack).
77	1x10 Prince Tone Black Mix .....Blackface Fender Princeton with 10" speaker (Producer Pack).
78	1x10 Prince Tone Silver Mix .....Silverface Fender Princeton with 10" speaker (Producer Pack).
79	1x12 Junior Blues Mix .....Fender Blues Junior with 12" speaker (Producer Pack).
80	1x12 Deluxe Verb Mix .....Fender Deluxe Reverb with 12" speaker (Producer Pack).
81	1x12 Deluxe Tweed Mix .....Fender Deluxe Tweed with 12" speaker (Producer Pack).

In Firmware 10 many of the factory cabs were remixed so as to sound more "in the room". The (V9) cabs have a more "studio-polished sound". Far field IRs: cabs 10, 28 and 29.

<u>AXE-FX CAB</u>	<u>DESCRIPTION</u>
82	1x12 Vibrato Lux Mix .....Fender Vibrolux with 12" speaker (Producer Pack).
83	1x12 Class-A 15w Blue Mix .....Vox AC-15 with 12" Alnico Blue (Producer Pack).
84	1x12 Division 13 Mix .....Divided By 13 CJ 11 with 12" G12M (Producer Pack).
85	1x12 Hot Kitty Mix .....Black Cat Hot Cat 30R with 12" proprietary Celestion speaker (V30) (Producer Pack).
86	1x12 Hawaii Mix .....Ohau cabinet (Producer Pack).
87	1x15 Tweed Pro Mix.....Fender Pro with 15" speaker (Producer Pack).
88	1x15 Empire Mix .....15" Eminence speaker (Producer Pack).
89	2x10 Super Tweed Mix .....Fender Super Reverb with two 10" speakers (Producer Pack).
90	2x10 Vibrato Lux Mix.....Fender Vibrolux with two 10" speakers (Producer Pack).
91	2x12 Double Verb Mix.....Fender Twin Reverb with two 12" speakers (Producer Pack).
92	2x12 Pro Verb Mix.....Fender Pro Reverb with two 12" speakers (Producer Pack).
93	2x12 Class-A 30w Blue Mix .....Vox AC-30 with two 12" Alnico Blue speakers (Producer Pack).
94	2x12 Class-A 30w Silver Mix .....Vox AC-30 with two 12" Alnico Silver speakers (Producer Pack).
95	2x12 Supremo Mix.....Supro with two 12" speakers (Producer Pack).
96	2x12 Santiago EJ1250 Mix.....12" Eminence EJ1250 50w speaker in a Fender closed-back cabinet (Producer Pack).
97	2x12 Santiago Altec Mix.....12" Altec 417-8H speaker in a x12 half-open cabinet (Producer Pack).
98	3x10 Vibrato King Mix.....Fender Vibro-King with three 10" speakers (Producer Pack).
99	4x10 Bassguy Mix.....Fender Bassman with four 10" speakers (Producer Pack).
100	4x10 Super Verb Mix.....Fender Super Reverb with four 10" speakers (Producer Pack).
101	4x12 Basketweave Green Mix.....Marshall cabinet with four 12" G12M (greenback) speakers (Producer Pack).
102	4x12 Basketweave AX Mix.....Marshall 1960AX (angled front) with four 12" (probably greenbacks) speakers (Producer Pack).
103	4x12 Basketweave TV Mix.....Marshall 1960TV angled tall cabinet with four 12" (probably greenbacks) speakers (Producer Pack).
104	4x12 Cali Lead 80s Mix .....Mesa cabinet from the 80s with four Classic Lead 80 speakers (Producer Pack).
105	4x12 Rumble EV12L Mix.....EVM 12L speakers in a 4x12 12L/12S Dumble cabinet (Producer Pack).
106	4x12 Rumble EV12S Mix.....EVM 12S speakers in a 4x12 12L/12S Dumble cabinet (Producer Pack).
107	4x12 PVH6160 Mix.....EVH 5150 cabinet (Producer Pack).
108	4x12 Petrucci V30 Mix.....John Petrucci's Mesa 4x12 cabinet with V30s (Producer Pack). Adam Cook: "The Petrucci V30 Mix is pretty dark but that is the way he mics his cabs. It's a two mic blend and neither mic is particularly close to the center of the cab. I compared the Petrucci V30 Mix to some IR's we captured at a previous session and they are very similar."
109	1x15 SV Bass M88 Mix .....1x15 bass cabinet, Beyerdynamic M88 microphone (Producer Pack).
110	1x15 SV Bass Subkick Mix .....1x15 bass cabinet, subkick (Producer Pack).
111	4x10 SV Bass M88 Mix .....4x10 bass cabinet, Beyerdynamic M88 microphone (Producer Pack).
112	4x10 SV Bass Subkick Mix .....4x10 bass cabinet, subkick (Producer Pack).
113	4x10+Tweeter SV Bass M88 Mix ....4x10 bass cabinet, M88 microphone (Producer Pack).
114	1x12 Class-A 20 Dlx Mix .....1x12 Morgan AC20 Deluxe cabinet (Producer Pack).
115	1x12 Nuclear Tone Mix .....Swart Atomic Space Tone cabinet, open back, 1x12 Mojotone British Vintage Series BV-25m speaker (Producer Pack).
116	1x12 Scumtone 25W Mix .....Cas Azera Tone-Tools detuned 1x12 cabinet with Scumback H55 (Producer Pack).
117	2x12 Boutique Mix.....2x12 Matchless cabinet (Producer Pack).
118	2x12 SV Legend Mix.....Carvin Legacy 2x12 cabinet, closed back (Producer Pack).
119	1x12 E12L (V9).....Firmware 9 version of cabinet 8.
120	1x12 Brit G12H30 (V9).....Firmware 9 version of cabinet 16.
121	2x12 Doubleverb D120 (V9) .....Firmware 9 version of cabinet 21.
122	2x12 Doubleverb C12N (V9) .....Firmware 9 version of cabinet 22.
123	2x15 Doubleshow (V9) .....Firmware 9 version of cabinet 31.
124	4x12 Basketweave G12H30 (V9) ....Firmware 9 version of cabinet 34.
125	4x12 1960B V30 (V9) .....Firmware 9 version of cabinet 41.

In Firmware 10 many of the factory cabs were remixed so as to sound more "in the room". The (V9) cabs have a more "studio-polished sound". Far field IRs: cabs 10, 28 and 29.

<u>AXE-FX CAB</u>	<u>DESCRIPTION</u>
126 4x12 Recto V30 (V9).....	Firmware 9 version of cabinet 43.
127 4x12 German V30 (V9) .....	Firmware 9 version of cabinet 47.
128 4x12 PVH6160 (V9).....	Firmware 9 version of cabinet 49.
129 4x12 Uber T75 (V9).....	Firmware 9 version of cabinet 50.
130 4x12 Uber V30 (V9).....	Firmware 9 version of cabinet 51.
131 4x12 Uber T75+V30 (V9).....	Firmware 9 version of cabinet 52.
132 4x12 Citrus V30 (V9).....	Firmware 9 version of cabinet 53.

---

In Firmware 10 many of the factory cabs were remixed so as to sound more "in the room". The (V9) cabs have a more "studio-polished sound". Far field IRs: cabs 10, 28 and 29.



<u>AXE-FX AMP</u>	<u>SPEAKER TYPE</u>	<u>AXE-FX CAB SUGGESTION</u>
1987x.....	G12M, G12H, G12L .....	see G12M and G12H footnotes; 35 (G12L)
5153.....	G12-EVH (G12H30) .....	49, 107, 128 (5150); G12Hs
59/65 Bassguy .....	4x10, 2x12 .....	32, 33, 99 (4x10)
AC-20 Dlx.....	Alnico Blue, G12H, Greenback .....	114
Atomica .....	G12H .....	16, 34, 57, 64, 120, 124 (G12H)
Band-Commander .....	2x12 (Jensen C12N) .....	19 (1x12); 21, 22, 91, 121, 122 (Twin)
Blankshp Leeds.....	2x10 Jensen C10Q, Alnico Blue .....	see Alnico footnote
Bludojai .....	G12-65, EVM 12L.....	29, 56 (G12-65), <b>G12-65 from Mad Oak Cab Pack</b> ; see EVM footnote
Boutique .....	G12M + G12H.....	26, 30, 117 (Matchless); 84, 116 (1xG12M)
Brit 800/Silver.....	G12M, G12H, V30, T75 .....	see G12M, G12H, and V30 footnotes; 39, 50, 73, 74, 129 (G12-T75); <b>Brit 800 from Mad Oak Cab Pack</b>
Brit JM45 .....	G12M, G12H, G12L .....	see G12M and G12H footnotes; 35 (G12L)
Brit JVM .....	V30 + G12H.....	see V30 and G12H footnotes
Brit Pre .....	(preamp).....	n/a
Brit Super.....	V30.....	see V30 footnote; <b>Brit 800 from Mad Oak Cab Pack</b>
Buttery .....	G12M, G12H .....	see G12M and G12H footnotes; 84, 116 (1xG12M)
CA3+ .....	(preamp).....	n/a
Cali Leggy .....	V30.....	118; other V30s, G12Ms
Cameron .....	G12H .....	see G12H footnote
CarolAnn OD-2.....	EVM 12L, Celestion Classic Lead 80.....	see EVM footnote; 104 (Classic Lead 80)
Citrus RV50 .....	V30.....	53 (Orange); see V30 footnote
Class-A 15w/30w.....	Alnico Blue, G12M.....	see Alnico and G12M footnotes; 114
Class-A 20 DLX.....	Alnico Blue, G12H, Greenback .....	114
Comet.....	Greenbacks, G12H, V30.....	see G12M, G12H, and V30 footnotes
Corncob M50 .....	60w V30 .....	see V30 footnote
Das Metall .....	V30, G12-K100 .....	see V30 footnote; 54 (G12K100)
Deluxe Tweed.....	Jensen P12R, C12N of Alnico Blue.....	14, 81 (Deluxe); see Alnico footnote; 5, 6, 19 (1x12)
Deluxe Verb.....	1x12 (Jensen C12Q, EVM 12L, JBL D120), 2x10 (Jensen C10N, C10Q, P10R).....	3, 5, 6; see EVM footnote; 21, 22, 121, 122 (Twin); 80, 81 (Deluxe)
Dirty Shirley .....	G12M, G12H .....	see G12M and G12H footnotes
Division13 CJ .....	G12M.....	84 (1x G12M)
Dizzy V4 .....	V30, G12K100.....	see V30 footnote; 54 (G12K100)
Double Verb .....	2x12 (Jensen C12N, JBL D120, EVM-12L) .....	21, 22, 91, 121, 122 (Twin); see EVM footnote; 6, 19
Energyball .....	V30, custom V60 .....	see V30 footnote
Euro Blue/Red .....	V30.....	see V30 footnote; G12Ms
Euro Uber.....	V30 + G12T75 (Uberkab) .....	50, 51, 52, 129, 120, 131 (Uberkab)
Fox ODS .....	G12-65, EVM 12L .....	29, 56 (G12-65), <b>G12-65 from Mad Oak Cab Pack</b> ; see EVM footnote
Friedman.....	G12M, G12H, V30.....	see G12M, G12H, and V30 footnotes
Fryette D60.....	Eminence P50E .....	?
Gibtone Scout .....	1x10.....	3, 4 (1x10); 84, 115, 116 (1xG12M)
Herbie.....	V30, G12K100.....	see V30 footnote; 54 (G12K100)
HiPower .....	4x12 Fane.....	42 (Hiwatt)
Hot Kitty.....	Bad Cat proprietary Celestion.....	85 (Bad Cat)
Jazz 120 .....	2x12 "silver" Roland .....	27 (Roland)
JR Blues.....	C12N, P12R .....	79 (JR Blues)
Mr Z 38 Sr.....	Alnico Blue + G12H.....	see Alnico and G12H footnotes; 114
Nuclear-Tone .....	G12M.....	115 (1x G12M)

Alnico cabs: 7, 11, 13, 15, 20, 24, 25, 28, 55, 83, 93, 94

EVM cabs: 8, 12, 105, 106, 119

G12H cabs: 16, 34, 57, 64, 120, 124

G12M cabs: 36, 37, 38, 58, 60, 61, 101, 102, 103

V30 cabs: 41, 43, 44, 47, 48, 51, 53, 59, 62, 63, 65, 69, 70, 71, 72, 108, 125, 126, 127, 130, 132

**Cab Pack IRs are highlighted in red.** Amps not listed have neither speaker types nor suggested cabs in the Axe-Fx II Wiki.

<u>AXE-FX AMP</u>	<u>SPEAKER TYPE</u>	<u>AXE-FX CAB SUGGESTION</u>
ODS-100.....	G12-65, EVM 12L .....	29, 56 (G12-65), <b>G12-65 from Mad Oak Cab Pack</b> ; see EVM footnote
Plexi.....	G12M, G12H, G12L .....	see G12M and G12H footnote; 35 (G12L)
Prince Tone .....	Jensen C10N.....	3 (1x10); 77, 78 (Princeton)
PVH 6160.....	Sheffield 1200.....	49, 107, 128 (5150); G12Ms, G12Hs
Recto.....	V30.....	see V30 footnote; 104 (Classic Lead 80)
Ruby Rocket .....	Alnico .....	see Alnico footnote; 114
Shiver .....	V30.....	see V30 footnote
Solo 88 Rhythm.....	(preamp).....	n/a
Solo 99 .....	(preamp).....	n/a
Solo 100.....	12" Eminence .....	45, 46 (Soldano); see EVM footnote
Spawn.....	G12M, G12-65, V30.....	see G12M footnote; 29, 56 (G12-65), <b>G12-65 from Mad Oak Cab Pack</b> ; see V30 footnote
Suhr Badger .....	V30.....	see V30 footnote; 85 (1xV30)
Super Verb.....	4x10 Jensen C10R, C10Q, P10R .....	89, 100 (Super)
Supremo Trem.....	6" oval speaker, 12" or 15" Jensen .....	18, 95 (Supro)
SV Bass .....	8x10.....	66, 67, 68, 109, 110, 111, 112, 113 (bass cabs)
Tube Pre.....	(preamp).....	n/a
Two-Stone J-35 .....	G12-65 .....	29, 56 (G12-65), <b>G12-65 from Mad Oak Cab Pack</b> ; see EVM footnote
TX Star Lead .....	Mesa C90 .....	see V30 and EVM footnotes; 104 (Classic Lead 80)
USA IIC+ .....	EVM 12L .....	see EVM footnote; 104 (Classic Lead 80)
USA Clean 2/Pre .....	(preamp).....	n/a
USA (all others) .....	Mesa C90 .....	see V30 and EVM footnotes; 104 (Classic Lead 80)
Vibrato-King.....	3x10.....	98 (Vibro-King)
Vibrato Lux .....	2x10 (Jensen C10Q), Oxford 1x12 .....	82, 90 (Vibrolux); EVM 12L
Vibrato Verb .....	1x15 (Jensen C15N, JBL D130, Eminence), 2x10 (Jensen C10Q) .....	18, 31, 87, 88, 123 (1x15)
Wrecker 1.....	G12M, G12H .....	see G12M and G12H footnotes

Alnico cabs: 7, 11, 13, 15, 20, 24, 25, 28, 55, 83, 93, 94

EVM cabs: 8, 12, 105, 106, 119

G12H cabs: 16, 34, 57, 64, 120, 124

G12M cabs: 36, 37, 38, 58, 60, 61, 101, 102, 103

V30 cabs: 41, 43, 44, 47, 48, 51, 53, 59, 62, 63, 65, 69, 70, 71, 72, 108, 125, 126, 127, 130, 132

**Cab Pack IRs are highlighted in red.** Amps not listed have neither speaker types nor suggested cabs in the Axe-Fx II Wiki.

## CC ASSIGNMENTS

sorted by function

<u>Function</u>	<u>CC</u>	<u>Function</u>	<u>CC</u>	<u>Function</u>	<u>CC</u>
Amp 1 Bypass	37	Filter 1 Bypass	52	Phaser 1 X/Y	112
Amp 1 X/Y	100	Filter 2 Bypass	53	Phaser 2 Bypass	76
Amp 2 Bypass	38	Filter 3 Bypass	54	Phaser 2 X/Y	113
Amp 2 X/Y	101	Filter 4 Bypass	55	Pitch 1 Bypass	77
Bypass	13	Flanger 1 Bypass	56	Pitch 1 X/Y	114
Cab 1 Bypass	39	Flanger 1 X/Y	110	Pitch 2 Bypass	78
Cab 1 X/Y	102	Flanger 2 Bypass	57	Pitch 2 X/Y	115
Cab 2 Bypass	40	Flanger 2 X/Y	111	Quad Chorus 1 Bypass	79
Cab 2 X/Y	103	Formant 1 Bypass	58	Quad Chorus 2 Bypass	80
Chorus 1 Bypass	41	FX Loop Bypass	59	Resonator 1 Bypass	81
Chorus 1 X/Y	104	Gate/Expander 1 Bypass	60	Resonator 2 Bypass	82
Chorus 2 Bypass	42	Gate/Expander 2 Bypass	61	Reverb 1 Bypass	83
Chorus 2 X/Y	105	Graphic EQ 1 Bypass	62	Reverb 1 X/Y	116
Compressor 1 Bypass	43	Graphic EQ 2 Bypass	63	Reverb 2 Bypass	84
Compressor 2 Bypass	44	Graphic EQ 3 Bypass	64	Reverb 2 X/Y	117
Crossover 1 Bypass	45	Graphic EQ 4 Bypass	65	Ring Modulator Bypass	85
Crossover 2 Bypass	46	Input Volume	10	Rotary 1 Bypass	86
Delay 1 Bypass	47	Looper Bypass	33	Rotary 2 Bypass	87
Delay 1 X/Y	106	Looper Dub	31	Scene Increment	123
Delay 2 Bypass	48	Looper Half	120	Scene Decrement	124
Delay 2 X/Y	107	Looper Once	30	Scene Select	34
Drive 1 Bypass	49	Looper Play	29	Synth 1 Bypass	88
Drive 1 X/Y	108	Looper Record	28	Synth 2 Bypass	89
Drive 2 Bypass	50	Looper Rev	32	Tempo	14
Drive 2 X/Y	109	Looper Undo	121	Tone Matching	99
Enhancer Bypass	51	Megatap Delay Bypass	66	Tremolo/Panner 1 Bypass	90
External Control 1	16	Metronome	122	Tremolo/Panner 2 Bypass	91
External Control 2	17	Multiband Comp 1 Bypass	67	Tuner	15
External Control 3	18	Multiband Comp 2 Bypass	68	Vocoder Bypass	92
External Control 4	19	Multi Delay 1 Bypass	69	Volume Decrement	36
External Control 5	20	Multi Delay 2 Bypass	70	Volume Increment	35
External Control 6	21	Out 1 Volume	11	Volume/Pan 1 Bypass	93
External Control 7	22	Out 2 Volume	12	Volume/Pan 2 Bypass	94
External Control 8	23	Parametric EQ 1 Bypass	71	Volume/Pan 3 Bypass	95
External Control 9	24	Parametric EQ 2 Bypass	72	Volume/Pan 4 Bypass	96
External Control 10	25	Parametric EQ 3 Bypass	73	Wahwah 1 Bypass	97
External Control 11	26	Parametric EQ 4 Bypass	74	Wahwah 1 X/Y	118
External Control 12	27	Phaser 1 Bypass	75	Wahwah 2 Bypass	98
				Wahwah 2 X/Y	119

## CC ASSIGNMENTS

sorted by CC

<u>Function</u>	<u>CC</u>	<u>Function</u>	<u>CC</u>	<u>Function</u>	<u>CC</u>
Input Volume . . . . .	10	Delay 2 Bypass . . . . .	48	Rotary 1 Bypass . . . . .	86
Out 1 Volume . . . . .	11	Drive 1 Bypass . . . . .	49	Rotary 2 Bypass . . . . .	87
Out 2 Volume . . . . .	12	Drive 2 Bypass . . . . .	50	Synth 1 Bypass . . . . .	88
Bypass . . . . .	13	Enhancer Bypass . . . . .	51	Synth 2 Bypass . . . . .	89
Tempo . . . . .	14	Filter 1 Bypass . . . . .	52	Tremolo/Panner 1 Bypass . .	90
Tuner . . . . .	15	Filter 2 Bypass . . . . .	53	Tremolo/Panner 2 Bypass . .	91
External Control 1 . . . . .	16	Filter 3 Bypass . . . . .	54	Vocoder Bypass . . . . .	92
External Control 2 . . . . .	17	Filter 4 Bypass . . . . .	55	Volume/Pan 1 Bypass . . . . .	93
External Control 3 . . . . .	18	Flanger 1 Bypass . . . . .	56	Volume/Pan 2 Bypass . . . . .	94
External Control 4 . . . . .	19	Flanger 2 Bypass . . . . .	57	Volume/Pan 3 Bypass . . . . .	95
External Control 5 . . . . .	20	Formant 1 Bypass . . . . .	58	Volume/Pan 4 Bypass . . . . .	96
External Control 6 . . . . .	21	FX Loop Bypass . . . . .	59	Wahwah 1 Bypass . . . . .	97
External Control 7 . . . . .	22	Gate/Expander 1 Bypass . . .	60	Wahwah 2 Bypass . . . . .	98
External Control 8 . . . . .	23	Gate/Expander 2 Bypass . . .	61	Tone Matching . . . . .	99
External Control 9 . . . . .	24	Graphic EQ 1 Bypass . . . . .	62	Amp 1 X/Y . . . . .	100
External Control 10 . . . . .	25	Graphic EQ 2 Bypass . . . . .	63	Amp 2 X/Y . . . . .	101
External Control 11 . . . . .	26	Graphic EQ 3 Bypass . . . . .	64	Cab 1 X/Y . . . . .	102
External Control 12 . . . . .	27	Graphic EQ 4 Bypass . . . . .	65	Cab 2 X/Y . . . . .	103
Looper Record . . . . .	28	Megatap Delay Bypass . . . . .	66	Chorus 1 X/Y . . . . .	104
Looper Play . . . . .	29	Multiband Comp 1 Bypass . .	67	Chorus 2 X/Y . . . . .	105
Looper Once . . . . .	30	Multiband Comp 2 Bypass . .	68	Delay 1 X/Y . . . . .	106
Looper Dub . . . . .	31	Multi Delay 1 Bypass . . . . .	69	Delay 2 X/Y . . . . .	107
Looper Rev . . . . .	32	Multi Delay 2 Bypass . . . . .	70	Drive 1 X/Y . . . . .	108
Looper Bypass . . . . .	33	Parametric EQ 1 Bypass . . .	71	Drive 2 X/Y . . . . .	109
Scene Select . . . . .	34	Parametric EQ 2 Bypass . . .	72	Flanger 1 X/Y . . . . .	110
Volume Increment . . . . .	35	Parametric EQ 3 Bypass . . .	73	Flanger 2 X/Y . . . . .	111
Volume Decrement . . . . .	36	Parametric EQ 4 Bypass . . .	74	Phaser 1 X/Y . . . . .	112
Amp 1 Bypass . . . . .	37	Phaser 1 Bypass . . . . .	75	Phaser 2 X/Y . . . . .	113
Amp 2 Bypass . . . . .	38	Phaser 2 Bypass . . . . .	76	Pitch 1 X/Y . . . . .	114
Cab 1 Bypass . . . . .	39	Pitch 1 Bypass . . . . .	77	Pitch 2 X/Y . . . . .	115
Cab 2 Bypass . . . . .	40	Pitch 2 Bypass . . . . .	78	Reverb 1 X/Y . . . . .	116
Chorus 1 Bypass . . . . .	41	Quad Chorus 1 Bypass . . . . .	79	Reverb 2 X/Y . . . . .	117
Chorus 2 Bypass . . . . .	42	Quad Chorus 2 Bypass . . . . .	80	Wahwah 1 X/Y . . . . .	118
Compressor 1 Bypass . . . . .	43	Resonator 1 Bypass . . . . .	81	Wahwah 2 X/Y . . . . .	119
Compressor 2 Bypass . . . . .	44	Resonator 2 Bypass . . . . .	82	Looper Half . . . . .	120
Crossover 1 Bypass . . . . .	45	Reverb 1 Bypass . . . . .	83	Looper Undo . . . . .	121
Crossover 2 Bypass . . . . .	46	Reverb 2 Bypass . . . . .	84	Metronome . . . . .	122
Delay 1 Bypass . . . . .	47	Ring Modulator Bypass . . . .	85	Scene Increment . . . . .	123
				Scene Decrement . . . . .	124

DRIVE BLOCK	DESCRIPTION
Rat Dist . . . . .	ProCo Rat Distortion
PI Fuzz . . . . .	Big Muff Pi Fuzz
Tube Drive . . . . .	Chandler Tube Driver that actually contains a 12AX7.
Super OD . . . . .	Boss Super Overdrive
Treble Boost . . . . .	Classic Treble Booster
Mid Boost . . . . .	Custom mid-boost overdrive
T808 OD . . . . .	Ibanez TS-808 Tube Screamer
Fat Rat . . . . .	Modified version of the Rat Dist; a bit fuller and smoother.
T808 MOD . . . . .	Captures the most popular 808 mods.
Octave Dist . . . . .	Tycobrahe Octavia
Plus Dist . . . . .	MXR Distortion Plus
Hard Fuzz . . . . .	Hard-clipping, 60s-style fuzz
FET Boost . . . . .	Gentle, smooth clipping booster with tone controls.
Tape Dist . . . . .	Simulates the clipping of an overdriven reel-to-reel tape deck.
Full OD . . . . .	Fulltone Fulldrive OD Pedal
Blues OD . . . . .	Marshall Bluesbreaker
Shred Dist . . . . .	Marshall Shredmaster
M-Zone Dist . . . . .	Boss Metalzone, popular for extreme gain settings.
Bender Fuzz . . . . .	Classic Tonebender circuit
BB Pre . . . . .	Xotic Pedals BB Preamp
Master Fuzz . . . . .	Maestro Fuzztone, aka Satisfaction fuzz
Face Fuzz . . . . .	Dallas Arbiter Fuzz Face
Bit Crusher . . . . .	A black box we found lying in the trash outside Studio Harshclip.
Eternal Love . . . . .	Lovepedal Eternity
Esoteric ACB . . . . .	Xotic AC Boost
Esoteric RCB . . . . .	Xotic RC Boost
Zen Master . . . . .	Hermida Zendrive

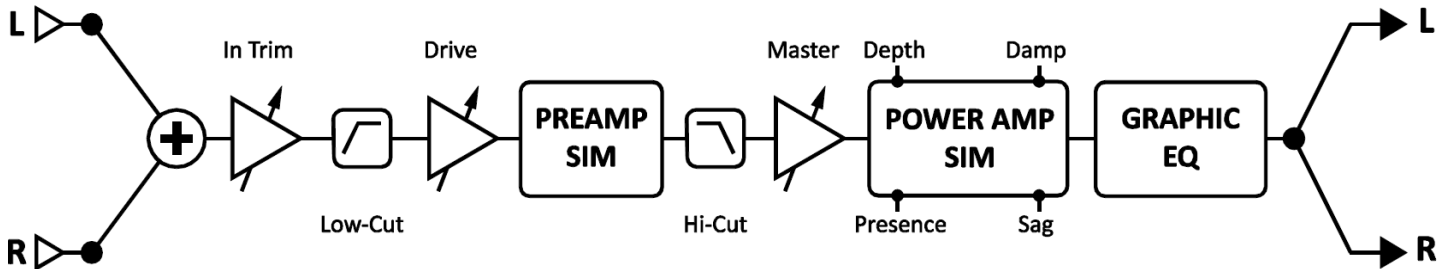

Mono Cab Sim

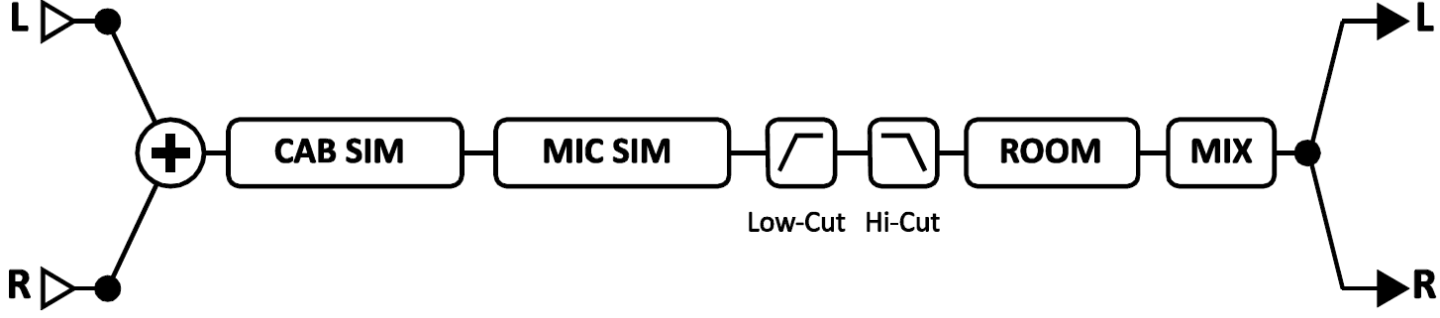

Stereo Cab Sim

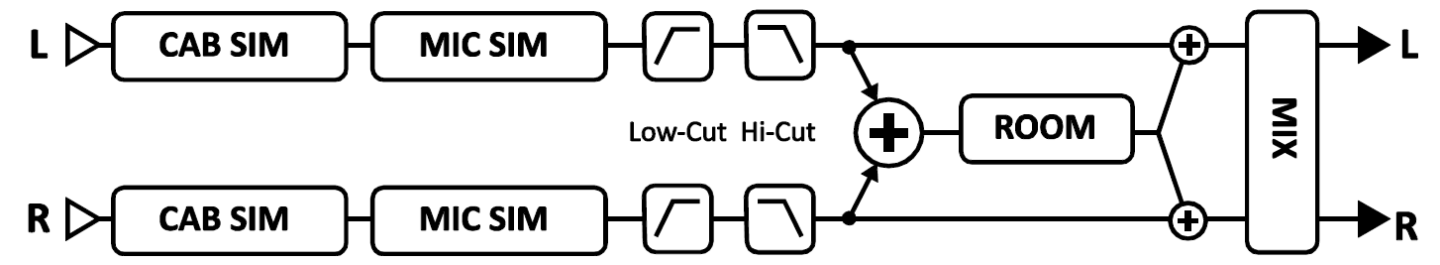

EVH 5150 III 100w AMP  
recommended settings from the manual  
red dots indicate Eddie's personal settings

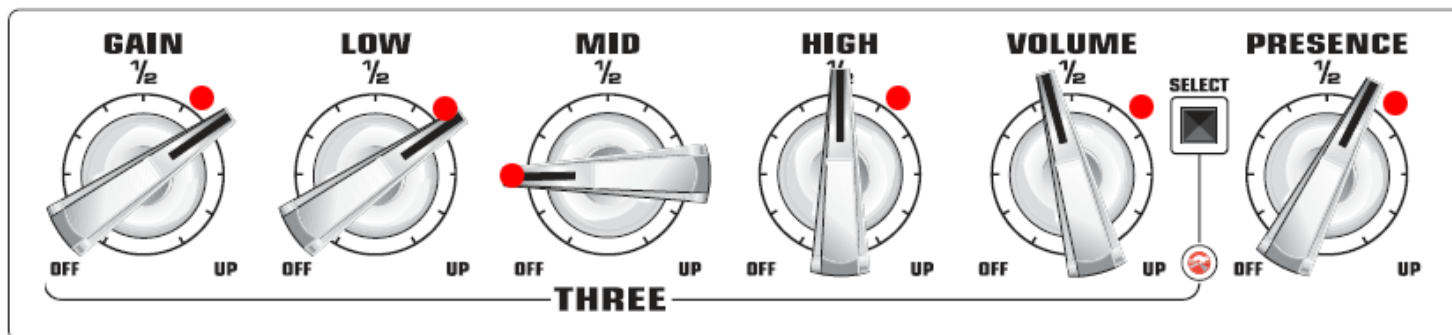
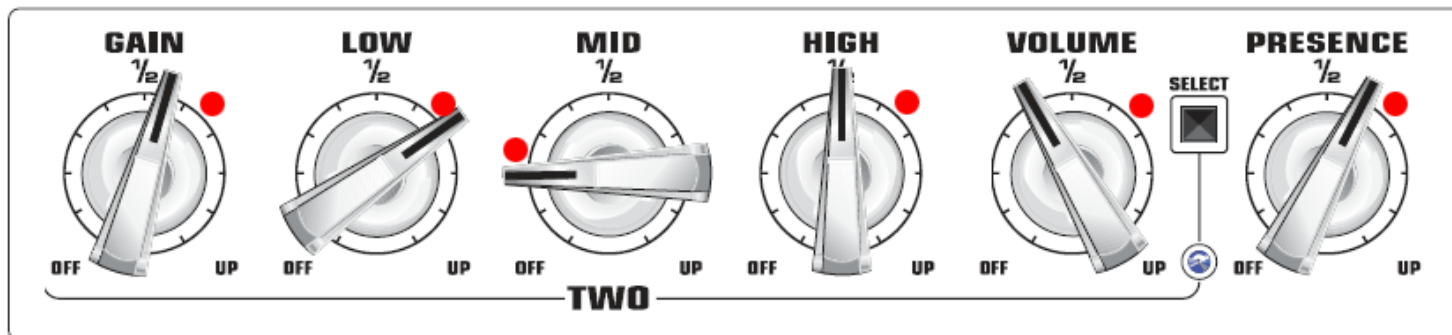
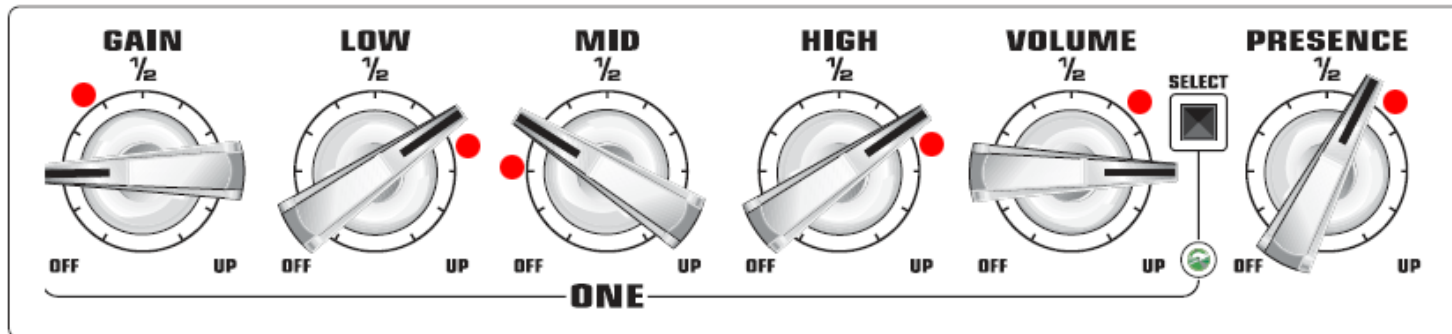

## REVISION HISTORY

2013-08-30 – Updated the description of the COMP parameter.

2013-08-28 – Firmware 11.0 update. Axe-Edit 3.0 update. Added footnote icon to amp list noting amps with no negative feedback.

2013-07-21 – Firmware 10.12 update.

2013-07-14 – Added CC assignment list, sorted by function and CC.

2013-07-08 – Firmware 10.11 update. Added Cab Pack recommendations from the Wiki to the cab suggestion list. Added footnote symbols to the amp description list to make it easier to spot specific amp features.

2013-07-03 – Firmware 10.10 update. Added a few informative “Cliff notes”. **Some functions are not yet viewable in Axe-Edit. These notes are highlighted in red on the Axe-Edit screenshot pages.**

2013-06-29 – Updated the cab suggestion list to include the new factory cabs introduced in firmware 10. The list now accurately reflects the information on the Axe-Fx II Wiki. Also gave it a badly needed overhaul to make it more readable.

2013-06-22 – Firmware 10.09 update.