

AXE-FX II



Amp & Cab Quick Reference Guide for Axe-Edit

Amp and cab block parameters explained
Amp and cab descriptions
Amp speaker types matched with Axe-Fx cabs
CC assignments sorted by function & CC
Drive block descriptions
Amp and cab block diagrams

content compiled from the Axe-Fx II manual, Wiki and forum suggestions, corrections, etc.: send a PM to JMA at the Fractal Audio forum

firmware v14.0 ~ Axe-Edit v3.0.7 ~ rev. April 1, 2014



TOP ROW

INPUT DRIVE – Also known as Drive, Volume, Gain, etc. It is the knob closest to the input jack. In many cases it has a bright cap so the frequency response will be dependent on the knob position. As the gain increases the tone shifts from a treble and upper mid emphasis to a bass and lower mid emphasis. On jumpered amps, this setting's label changes to **TREBLE DRIVE**.

OVERDRIVE – A second drive control for some amp models. It does not have a bright cap so it only affects the gain. Set Overdrive to 8.00 to get the identical response to pre-v10.10 firmware for models that have Overdrive. On jumpered amps, this setting's label changes to **NORMAL DRIVE**.

INPUT DRIVE and OVERDRIVE will have a dramatic effect on the response of the amplifier and the personality of your instrument.

BASS/MID/TREB – “Passive” tone stack. Can be changed with **TONESTACK TYPE**.

For most tone stacks, when you set the BASS and TREB to zero, the tone stack becomes basically “flat” and the MID becomes a volume control.

CF COMP – Controls the amount of preamp compression and sets the compression threshold of the cathode follower. Many models default to zero as they do not have measurable compression.

PRESENCE – Decreases high frequency negative feedback in the power amp. Increased increase it to help sound cut through a heavy mix. Decrease it to compensate for overly-bright amps. It is tightly coupled to speaker impedance (**HI FREQ**, **HI RESONANCE**.)

HI CUT – On amps with no negative feedback (**DAMPING=0**), Presence is replaced with Hi Cut, a simple high-shelf EQ at the power amp output.

DEPTH – Boosts low frequencies from the power amp by varying the negative feedback frequency response. On amps with a fixed depth circuit, Depth will have a preset value. Also called “Resonance” or “Girth” on some amps.

DEPTH and PRESENCE differ from BASS, TREBLE and BRIGHTNESS (Tone page) in that they are applied to the power amp as opposed to the preamp.

MASTER VOL – Determines the amount of power amp distortion. As it increases, the tone controls have less influence on the sound. Amp models default to a starting Master Volume setting when selected. (Non-MV amps default to 10.)

MASTER VOL defaults to 10 for non-master volume (vintage) amps. If you want more MV on non-MV amps, increase MASTER VOL TRIM.

Most MV amps achieve full volume between 2-4. Further increase compresses the bass and treble, thereby adding mids. (Bass and treble are boosted by the speaker impedance curve, so they clip earlier.) The sweet spot is that point at which the power amp starts to compress. If you want a more “open” sound, be careful not to set the MV too high. You can also lower **XFORMER MATCH** (a little goes a long way.)

Modern high-gain amps can easily push the power amp into clipping at relatively low MV settings. With a real amp, it gets incredibly loud at those settings so you instinctively reduce the MV. In our virtual world we are unaware of how hard the virtual power amp is being pushed. Don't be surprised if a high-gain amp sounds best with the MV around 2. (Increase **LEVEL** to compensate for low MV.)

BOTTOM ROW

INPUT TRIM – A clean, linear gain applied at the input to the amp block that adjusts the relative gain of the preamp. (This is analogous to changing the type of tube for V1 in an actual amp.) It does the same thing as the **BOOST** switch, the difference being that you can control how much is boosted or cut (+/-20 dB). As a rule of thumb, every 2x multiplier equals +6dB boost. In other words, Input Trim at 4.0 produces a +12dB boost. Input Trim should be set to 1.00 if you want to match the actual amp.

You can also adjust preamp gain globally with **GLOBAL AMP GAIN**, which affects every amp and preset. One reason you might do this is to compensate for the gain difference when switching to a hotter/quieter guitar.

On the Axe-Fx unit: **GLOBAL button > CONFIG > AMP GAIN**

BOOST – Toggles the input boost for an additional 12 dB of input gain. Enabling Boost sometimes works better than turning up preamp gain.

CUT – Reduces the amount of low frequencies into the amp. This can be used to achieve a tighter tone or to reduce low-end “flub”. This is similar to increasing **LOW CUT** (Tone page) while still retaining some low end so it doesn't get thin. Provides an easy way to cut the overpowering bass in models such as Recto, Splawn Nitro, Komet and others.

FAT – Emphasizes midrange “body” by shifting down the tone stack center frequency. Specifically, it multiplies the tone stack treble capacitor by four. Depending upon the type of tone stack, tone control settings, position, etc., the effect can be more or less noticeable. (See **TONE** page.)

BRIGHT – A “treble peaker” which functions mainly to compensate for the loss of highs at low amp volume. The effect may be subtle or quite pronounced, depending on the amp selected, and it is also affected by the **BRIGHT CAP**.

SATURATION – Switches in a zener diode clipping stage between the preamp and the tone stack (the “Arrendondo Mod”) for more aggressive distortion character which also adds compression and cuts volume. You may have to adjust the **MASTER** or **LEVEL** to compensate.

SATURATION changes the distortion character. To preserve the distortion character and tone use **BOOST** or **INPUT TRIM** instead.

DYNAMIC PRESENCE – Models the output transformer leakage inductance that results in a brightening of the tone when the power amp is pushed. Increasing this value results in a brighter response as the virtual power amp is pushed. When playing softly or at lower gains, the influence of this control is lessened. Note that this only affects the power amp modeling and is dependent on the degree of power amp overdrive. This control can also be set negative to cause the tone to darken when playing hard. This control can also be used to help “dial in” the sweet spot of an amp model. As the MV is increased an amp becomes more liquid, compressed and easier to play. However, the highs may get overly compressed causing the amp to sound too dark. The **Dynamic Presence** control allows you to get the desired power amp drive and liquid feeling and then bring the highs back without affecting the rest of the spectrum.

DYNAMIC DEPTH – Analogous to the **Dynamic Presence** control, this increases or decreases low frequencies when the virtual amp is being pushed. While real amps don't display this behavior, it is a valuable tone-shaping tool.

MASTER VOL TRIM – Can be used to increase (or decrease) the Master Volume for non-MV amps. If MV is 10 and you set MV Trim to 2.0 then the MV will be 20.



TOP ROW

LOW RES FREQ/RES Q/RESONANCE – Guitar loudspeakers have a low-frequency resonance, typically about 100 Hz. This shifts up slightly when the speaker is mounted in an enclosure and is typically lower for open back cabs. This resonance causes an increase in the power amplifier response due to the finite output impedance of the power amp. The default LF Resonance is based on the cab most likely to be used with that amp.

Don't be afraid to turn LOW RESONANCE close to 10. In fact, some Celestion and Eminence speakers are equivalent to about 8-9 on LOW RESONANCE. This will increase the interaction between the power tubes and the speaker load.

HI FREQ – Sets the “corner frequency” of the speaker impedance rise due to voice-coil inductance. The speaker voice-coil presents an inductive load to the power amp at high frequencies. This inductive load, in conjunction with the output transformer capacitance, creates a high-frequency resonance. Typical guitar speakers have a corner frequency between 1 kHz and 2 kHz. Lower values give more midrange emphasis.

HI RESONANCE – Similar to HI FREQ but this control only changes the slope of the resonance. Default value is consistent with typical “semi-inductance” of speaker voice-coil. Varying this value will change the high-frequency load presented to the power tubes.

BOTTOM ROW

XFORMER LOW/HIGH FREQ – These set the output transformer bandwidth.
SPEAKER DRIVE – Simulates distortion caused by pushing a speaker too far. It interacts with the MASTER.

The SPEAKER page is not an EQ. It allows you to adjust the impedance that the virtual speaker presents to the virtual power tubes. For a guitar amp with no negative feedback, the voltage frequency response of the power amp will very closely match this since the power amp is basically a current source. For a guitar amp with negative feedback, the resulting EQ is quite different than the impedance curve since negative feedback flattens the response. If you turn DAMPING all the way down then the EQ will be close to the impedance curve (but still influenced by the transformer.)



TOP ROW

SUPPLY SAG – Controls power supply impedance. Higher settings simulate higher power supply impedance, causing greater tube plate voltage (B+) “droop” and giving a more compressed, spongy and looser feel. Sag interacts with the MASTER: as the power amp is pushed and draws more current from its power supply, Sag has more effect. Sag values around 2 simulate a solid-state rectifier, 4-6 a tube rectifier.

In general, the more heavily driven the power amp section is, the more effect the SUPPLY SAG. Setting SUPPLY SAG to 0 disables the power amp and turns the MASTER into a simple level control with a 40 dB range.

PREAMP SAG – OFF replicates the behavior of separate preamp and power amp. ON replicates the behavior of an integrated tube head or combo amp.

PICK ATTACK – Controls a sophisticated dynamic range processor that operates on leading edge transients. Negative values reduce pick attack while positive values enhance it.

THUNK – Allows adding “weight” to tones by simulating the very low-frequency interaction of a speaker cabinet with the guitar. Higher values simulate closer proximity of the guitar to the cabinet.

XFORMER MATCH – One of the most powerful controls in the amp block. It changes the turns ratio (and therefore the primary impedance) of the output transformer, which controls how easily power tubes are driven into clipping. Decreasing causes the power tubes to clip later, the phase inverter and grid clipping become more predominant, and the speaker resonance will be more pronounced. You also reduce the power tube compression of the lows and highs. This control has more influence with higher MASTER values and low gain amps and less influence with highly compressed amps. Increase MASTER until desired amount of power amp distortion is achieved, then adjust XFormer Match for sound’s character: higher = more compressed, lower = more open. The LF/HF RESONANCE parameters interact strongly with this parameter.

Use XFORMER MATCH to intentionally mismatch speaker impedance in order to get a different tone. To simulate plugging an 8-ohm speaker into a 4-ohm jack, set it to 2.0. For the other way around, set it to 0.5.

The cathode follower algorithm has three adjustable parameters:

CF COMP – Controls the amount of preamp compression and sets the compression threshold of the cathode follower. Many models default to zero as they do not have measureable compression.

CATHODE TIME – Sets the attack time of the compressor.

CATHODE RATIO – Sets the maximum amount of compression, with lower values giving more compression.

BOTTOM ROW

B+ TIME CONSTANT – Associated with SUPPLY SAG. Controls rate of change in power tube plate supply. “B+” refers to one of the high voltage “taps” or outputs of the main power transformer. Lower values give a bouncier feel, while higher values give a tighter, more aggressive feel. The effect of lower B+ is equivalent to increasing XFORMER MATCH. A lower B+ means the plates clip sooner which is the same as increasing the turns ratio on the transformer. This is assuming that you rebias since typically lower the B+ affects the bias.

DYNAMICS TIME – Controls how fast DYNAMICS happens.

BIAS EXCURSION – GRID MODELING parameter that controls how much the power tube grid voltage droops when the grids conduct.

EXCURSION/RECOVERY TIME – GRID MODELING parameter that controls the time constants associated with BIAS EXCURSION.

XFORMER DRIVE – Sets the amount of core saturation in the output transformer, controlling how hard the transformer is driven. Higher values simulate a smaller, more easily saturated transformer.

PREAMP BIAS – Controls the bias point of the last triode (cathode follower not counted) in the preamp. Depending on the bias points of the previous stages increasing or decreasing this value can alter both the harmonic content (the ratio of even/odd harmonics) and the attack characteristics. The further you move away from (roughly) zero the more even harmonics are introduced. It’s an asymmetric transfer function so you have to experiment. Typically, if the previous stage has a negative bias then increasing this value will be more noticeable and vice-versa. Use with TRIODE HARDNESS.

The cathode “squish” modeling algorithm improves the feel of cathode-biased power amp models (Class-A, Mr Z, etc.) It has two adjustable parameters:

CATHODE SQUISH – Sets the amount of bias shift due to cathode voltage rise. (Zero defeats the cathode squish modeling.)

SQUISH TIME – Sets the time constant of the cathode network.

Ghost notes are the result of a 120Hz signal plus harmonics getting past the power supply filtering. High SUPPLY SAG along with low B+ TIME CONSTANT can cause “ghost notes” when POWER SUPPLY TYPE is AC (as in a real amp). Lower B+ Time Constant values will make the amp feel “faster” but too low can cause ghost notes.

To hear what ghosts notes sound like, try the following: take an amp like Plexi 100W, turn the SAG up and the B+ TIME CONSTANT down, then play single notes around the 5th fret on the G string. You should hear a tone unrelated to the pitched note.



TOP ROW

PRESENCE FREQ – Alters the center frequency of the amp’s PRESENCE control.

DEPTH FREQ – Alters the center frequency of the amp’s DEPTH control.

DYNAMIC DAMPING – Adjusts the plate characteristics. Defaults to the appropriate value when an amp model or power tube type is selected.

POWER TUBE TYPE – Selects a specific power tube type and sets DYNAMIC DAMPING. This doesn’t change the sound in the same way actually changing tubes would because it only changes the distortion curves, not the transconductance. In real amps, an EL34 has more than twice the transconductance of a 6L6. This means the plate current will be twice as great for a given grid voltage. This makes EL34s sound “more midrangey” and 6L6s sound “tighter” or “fuller”.

POWER TUBE BIAS – Sets the bias point of the power amp. Increase it to reduce crossover distortion and vice-versa. Lower values approach pure Class-B operation. Higher values approach pure Class-A.

Increase POWER TUBE BIAS to thicken clean tones; reduce it to add aggression to high-gain sounds. A value of 0.5 or so will run the virtual tubes at around 75% of full power and clean tones will sound warmer but you will lose that sizzle on high-gain tones.

DAMPING – Controls the amount of negative feedback in the power amp. The feedback decreases output impedance, causing the amp to react less to the speakers (“damping”). Higher values give a brighter, tighter, punchier sound but can be harsh at very high MASTER levels. Lower values give a smoother, loose and gritty sound and feel.

Setting DAMPING to 0 disables negative feedback and replaces the PRESENCE control with HI CUT. DEPTH is also disabled since it only affects negative feedback.

POWER TYPE – When set to AC, models AC rectification and resulting supply ripple. High SUPPLY SAG along with low B+ TIME CONSTANT can cause “ghost notes” when the supply type is AC (as in a real amp). Lower B+ Time Constant values will make the amp feel “faster” but too low can cause ghost notes.

AC LINE FREQ – Selects the line frequency.

BOTTOM ROW

TRIODE1/2 PLATE FREQ – Sets the cutoff frequency of the plate impedance for the next-to-last (triode 1) and last (triode 2) triode in the chain, which allows you to control the buzziness that sometimes occurs with higher gain settings. The capacitor across the triode’s plate resistor is used to smooth the response and reduce noise. You can adjust the amount of capacitance, and the resulting frequency. Lowering the frequencies dials out sharpness and “fizz”, making the tone smoother.

TRIODE HARDNESS – Controls how sharply the triodes enter saturation and can be used to simulate softer/harder tubes. The effect is subtle and most apparent at edge of breakup. Lower values give softer saturation and will sound softer (naturally) but have less note separation. Triode Hardness at zero gives a smoother distortion with reduced upper harmonics. Higher values give a more aggressive breakup and better note separation. Defaults to an appropriate value when an amp model is selected.

If you are right on the edge of breakup the triode hardness is very powerful as it controls the harmonic series. Higher values will cause the overtone series to have a less steep decay and will increase perceived “sparkle”. Together with PREAMP BIAS you can control how chimey and “round” the tone is.

MV LOCATION – Location of the Master Volume.

PRE-PI – Before the phaser inverter (most amps).

POST-PI – After the phase inverter (AC types). This causes the PI to clip before the grids (if the MV is less than full). This creates a very aggressive and open sound.

PRE-TRIODE – Amp types based on Hiwatt models.

POST-PI MV turns a lot of mid-gain amps into ripping monsters. The only caveat is that, like a real amp, the more you turn the MV down the less effective Presence and Depth become (since the loop gain is reduced).

POWER AMP LOW/HI CUT – Low/high pass filters placed after the power amp section that shape the tonal color of the power amp. Note that AMP VOICING also sets these values. Reduce Hi Cut to remove unwanted “fizz”.

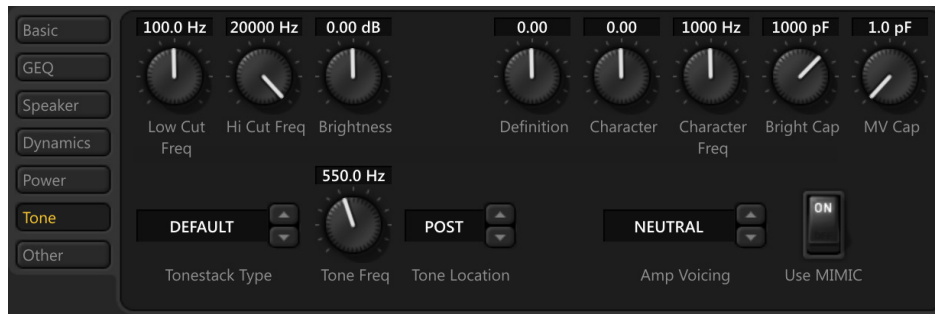

TOP ROW

LOW CUT FREQ – Reduces the amount of low frequency (10-1000Hz) before the preamp input. Use this is to tighten up a tubby bass end. Somewhere between 10-150Hz is generally where it will sound best for standard guitar tones. Also see CUT (Basic page).

HIGH CUT FREQ – Reduces the amount of high frequency (2k-20kHz) after the preamp output. Lower the value to make your top end sound smooth and silky, raise it to make it brilliant and defined.

BRIGHTNESS – High treble control shelving filter between the preamp and power amp. It may be used to darken or brighten the output of the preamp. It accurately replicates the “Presence” control found in the Mesa Triaxis preamp when set to negative values. (In the Triaxis, it is actually a high frequency cut shelving filter.) Note: this is not to be confused with the BRIGHT switch which engages/disengages a capacitor across the drive pot.

DEFINITION – A basic “tilt EQ” located at the amp input. It changes the fundamental character of the amp from vintage to modern or vice-versa. Positive values increase the amount of upper overtone saturation, negative values reinforce lower harmonics.

CHARACTER/FREQ – These two parameters control powerful “inverse homomorphic filters”. When playing softly this dynamic filter has little effect on the sound. As the amount of distortion increases, the influence of the filter increases. The Character Frequency control sets the center frequency of the filter while the Character control sets how pronounced the effect is. For example, to darken the tone when playing harder, one might set the frequency to 10 kHz and the amount to -5. Setting the amount to +5 will make the tone brighter when playing hard.

BRIGHT CAP – Sets the value of the capacitor which determines the sonic effect of the BRIGHT switch. Increase to make the preamp brighter and vice-versa.

MV CAP – Sets the value of the bright cap across the Master Volume pot. Setting it to 1.0 pF disables it.

BOTTOM ROW

TONESTACK TYPE

ACTIVE – Gives each tone control ± 12 dB boost/cut making them more sensitive; they also will not interact with each other.

DEFAULT – Matches the tone stack with the selected amp type.

[AMP] – Replaces the default tone stack with one from another amp.

The tone stack is one of the main things that gives an amp its particular voice, as it shapes the frequency response pretty drastically.
For a flat tone stack, set the TONESTACK TYPE to NEUTRAL with B/M/T at noon. This allows the flexibility of being able to boost or cut bass and treble.

TONE FREQ – Sets the center frequency of the tone controls. This control works whether you are using PASSIVE, ACTIVE, or substitute tone stacks.

TONE LOCATION

PRE – Places the tone stack at the input to the preamp.

POST – Places it between the preamp and power amp.

MID – Places it between the last two triode stages.

END – Places it after the power amp (which is impossible with a real amp).

The farther upstream you position the stack, the thinner the sound.

MID will sound chunkiest, with END being rather dark.

AMP VOICING – Voices the amp to a variety of tonal styles. Choose “Neutral” for the raw amp sound or one of the other voicings for a quick “mix-ready” tone. Affects POWER AMP LOW/HI CUT values and applies some parametric EQ.

USE MIMIC – Identifies deviations in the response of the simulated amplifier to the actual amplifier and generates corrective data bringing a level of accuracy that has been heretofore unachievable.

TONESTACK TYPES

BROWNFACE (Vibroverb) ¹	WRECKER 1	RECTO2 ORG	BADGER 30	TRIPTIK LD	ANGLE SEVERE 1
BLACKFACE (Twin Reverb) ¹	NEUTRAL ²	RECTO2 RED	BRIT SILVER	TRIPTIK CLN	BRIT 800 ⁴
BASSGUY	CA3+SE	SHIVER CLN	SUPER VERB	JAZZ 120	RECTO1 ORG MDRN
TOP BOOST	FREYER D60	CAMERON	HOT KITTY	BOGFISH	ANGLE SEVERE 2
PLEXI	MR Z 38 SR	BRIT JVM OD1	VIBRATO-KING	WRECKER 2	USA PRE LD1 RED
BOUTIQUE	EURO UBER	BRIT JVM OD2	GIBTONE SCOUT	SKYLINE DEEP ³	RECTO ORG BRT
HI POWER	PVH 6160	5153 GREEN	CA3+SE CLEAN	USA SUB BLUES	RECTO RED BRT
USA NORMAL	SOLO 100	5153 BLUE	BF FIXED MID	WRECKER LVRPOOL	
USA FAT	CORNCOB	5153 RED	GERMAN V4	CITRUS A30 CLN	
RECTO1 ORG	XTC (Bogner)	BRIT SUPER	VIBRATO-LUX	CITRUS A30 DRT	
RECTO1 RED	CAROLANN	DIV13 CJ	DIRTY SHIRLEY	CAR ROAMER	
SKYLINE (Dumble)	CITRUS	BADGER 18	PLEXI 100W	USA BASS	
GERMAN	BRIT JM45	ATOMICA	ROCKET	CITRUS BASS	
JR BLUES	USA RHY	SPAWN	CONCOURSE	STUDIO	

¹ Generally, Blackface amps are cleaner with scooped mids. Brownface amps have more mids and fall in between Blackface (cleaner) and Tweed (dirtier).

² Previously named VINTAGE.

³ Deep switch engaged.

⁴ Identical to a Plexi tone stack except for the load resistance.

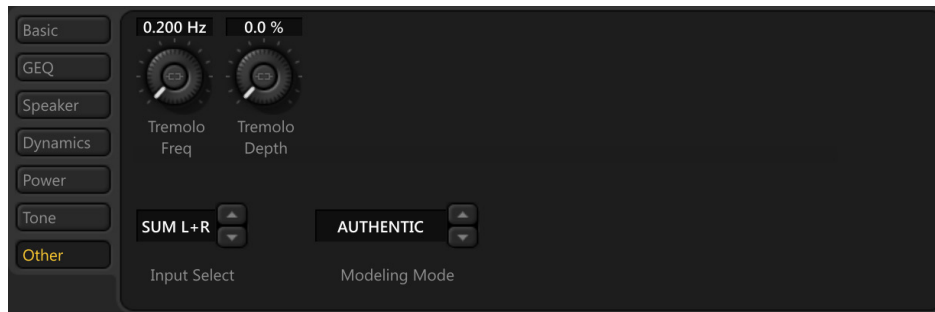

TOP ROW

TREMOLO FREQ/DEPTH (bias tremolo) – Works by varying the bias of the virtual power tubes, resulting in a particularly “organic” sound. Most importantly, the tremolo is “self-ducking” and decreases at higher signal amplitudes. On some amps high values of bias trem depth can result in excessive crossover distortion. On others, the tremolo can vary greatly between loud and soft playing.

BOTTOM ROW

INPUT SELECT – The Amp block processes audio in mono. This control determines how incoming stereo signals will be processed.

MODELING MODE – Varies between “realistic” and “idealized” preamp and power amp modeling.

AUTHENTIC – Replicates a tube amplifier with the utmost accuracy.

GRID COND OFF – Turns off grid conduction modeling in the power amp simulation. This reduces blocking distortion.

SMOOTH – Sets Triode Hardness to the minimum value essentially creating an ideal preamp and turns off grid conduction modeling in the power amp. This removes most of the “nasty” distortion that tube amps create.

IDEAL – Removes most of the “warts” from the modeling which includes grid conduction, output transformer distortion, bias shifting, and AC power supply modeling. Supply sag, screen voltage effects, and crossover distortion are still modeled.

IDEAL/SMOOTH – Same as Smooth, except it also sets Triode Hardness to its lowest value. This is in essence an ideal preamp plus an ideal power amp.

ADDITIONAL NOTES ON MODELING MODE

The audibility of these settings is dependent upon the particular amp model and various parameters. The use of these modes in conjunction with other parameters can yield idealized tones not achievable with real tube amps.

The first two choices duplicate the previous behavior of the deprecated Grid Modeling* parameter so no changes are required to existing presets.

When IDEAL is chosen, the global Modeling Version parameter is irrelevant.

* Grid modeling replicates grid conduction in the preamp and power amp stages, which adds “real world” high frequency “fizz” or “grit”. Grid modeling parameters include BIAS EXCURSION and EXCURSION/RECOVERY TIME.



TOP ROW

CAB – Loads a cabinet impulse response (IR). The older FAS and RW cabs were recorded with neutral mics. OH, Kalthallen, and the Mix/Producer Pack series have matching mics included in the IR.

SPEAKER SIZE (NORMAL/HI RES ONLY) – “Scales” the IR to simulate shrinking or enlarging of the speaker. This effect can be used to shift where the tone sits in a mix, or to create dramatic effects. Subtle settings (0.9-1.1) will sound most natural. UltraRes IRs do not support size warping, therefore, this parameter is disabled for UltraRes cabinets.

MOTOR DRIVE – Models the effect of high power levels on speaker tone. Simulates the impedance and distortion effects that occur when the speaker is pushed hard. Be aware this setting adds a little compression as you increase it. NOTE: This parameter appears on the ROOM page for stereo cabs.

BOTTOM ROW

MIC – Don’t feel that you have to add a mic unless you *want* to add EQ, which is basically what you would be doing.

LOW/HIGH CUT – Adjusts the cutoff point of first order low/high pass filters. Increase the Low Cut if the sound is too “bassy” or “boomy.” Decrease the High Cut for a darker cab tone. Common settings are 80-150 Hz for high pass, and 5-7 kHz for low pass.

PROXIMITY – Causes an increase in bass or low frequency response as proximity is increased (closer to speaker). Disabled when MIC is set to None.

PROXIMITY FREQ – This allows tuning the frequency range over which the proximity effect occurs. NOTE: This parameter appears on the ROOM page for stereo cabs.

DELAY – Delays the signal up to 1 second. With cab in stereo mode or with two cab blocks in parallel, delaying one cab relative to the other can achieve interesting comb filter effects. A common practice in studio recording is to use multiple mics on a speaker at different distances to intentionally introduce it. The effect is most pronounced when the cabs are summed to mono.



TOP ROW

ROOM LEVEL/SIZE – Determines the level and size of room reverb that is built into the cab block. Increase to add room ambience to the sound.

MIC SPACING – Increases delay times inside the room reverb by simulating the distance of the room microphone from the sound source.

AIR - Mixes some of the signal going into the Cab block with the signal leaving the Cab block.

AIR FREQUENCY – Sets the cutoff frequency of the mixed signal. Increase to maximum value for a straight mix.

BOTTOM ROW

INPUT SELECT – Can be used to run two Cabinet blocks in parallel for stereo processing by setting one to Left and the other to Right. Use this technique when you want to use UltraRes IRs in stereo.



EFFECT TYPE

HI/ULTRA RES – mono processing of Hi Res IRs (2048 samples, 43ms), or UltraRes IRs (up to 8000 samples, 167ms.)

NORMAL RES – mono processing of normal resolution IRs (1024 samples, 21ms.)

STEREO – stereo processing at normal resolution (2 x 1024.)
To calculate length: 1 millisecond = 48 samples.

LINK (CABINET Page - STEREO ONLY) – Sets the left channel parameters as master controls, which set identical values for left and right. You can still set right channel values independently.

UltraRes enhances the spectral resolution of an IR without adding CPU burden. To use UltraRes in stereo, see INPUT SELECT.

MIC TYPES

- 57 DYN – Shure SM57
- 58 DYN – Shure SM58
- 421 DYN – Sennheiser MD 421 II
- 87A COND – Shure Beta 87A
- U87 COND – Neumann U87
- E609 DYN – Sennheiser e609 Silver
- RE16 DYN – Electro-Voice RE16
- R121 COND – Royer Labs R-121
- D112 DYN – AKG D112
- 67 COND – Neumann U67
- NULL – allows PROXIMITY without a mic

FACTORY CABINETS

1	1x6 Oval	39	4x12 1960B T75 (RW)	77	1x10 Prince Tone Black Mix	115	1x12 Nuclear Tone Mix
2	1x8 Tweed	40	4x12 1960B K120 (RW)	78	1x10 Prince Tone Silver Mix	116	1x12 Scumtone 25W Mix
3	1x10 Gold	41	4x12 1960B V30 (RW)	79	1x12 Junior Blues Mix	117	2x12 Boutique Mix
4	1x10 Blue	42	4x12 Hi-Power (RW)	80	1x12 Deluxe Verb Mix	118	2x12 SV Legend Mix
5	1x12 Tweed	43	4x12 Recto V30 (RW)	81	1x12 Deluxe Tweed Mix	119	1x12 E12L (V9)
6	1x12 Black	44	4x12 Recto V30 (OH)	82	1x12 Vibrato Lux Mix	120	1x12 Brit G12H30 (V9)
7	1x12 Blue	45	4x12 Solo V12 (RW)	83	1x12 Class-A 15w Blue Mix	121	2x12 Doubleverb D120 (V9)
8	1x12 E12L (RW)	46	4x12 Solo S12X (RW)	84	1x12 Division 13 Mix	122	2x12 Doubleverb C12N (V9)
9	1x12 Studio	47	4x12 German V30 (RW)	85	1x12 Hot Kitty Mix	123	2x15 Doubleshow (V9)
10	1x12 EMI Open Back (JM)	48	4x12 German Boutique (RW)	86	1x12 Hawaii Mix	124	4x12 Basketweave G12H30 (V9)
11	1x12 Boogafunk Blue (OH)	49	4x12 PVH6160 (RW)	87	1x15 Tweed Pro Mix	125	4x12 1960B V30 (V9)
12	1x12 Boogafunk E12L (OH)	50	4x12 Uber T75 (RW)	88	1x15 Empire Mix	126	4x12 Recto V30 (V9)
13	1x12 Tweed Blue (RW)	51	4x12 Uber V30 (RW)	89	2x10 Super Tweed Mix	127	4x12 German V30 (V9)
14	1x12 Tweed Deluxe (RW)	52	4x12 Uber T75+V30 (RW)	90	2x10 Vibrato Lux Mix	128	4x12 PVH6160 (V9)
15	1x12 Brit Blue (RW)	53	4x12 Citrus V30 (RW)	91	2x12 Double Verb Mix	129	4x12 Uber T75 (V9)
16	1x12 Brit G12H30 (RW)	54	4x12 Mills 12K (OH)	92	2x12 Pro Verb Mix	130	4x12 Uber V30 (V9)
17	1x15 Blues	55	4x12 SLM Blue (OH)	93	2x12 Class-A 30w Blue Mix	131	4x12 Uber T75+V30 (V9)
18	1x15 Thunderbolt (RW)	56	4x12 SLM G65 (OH)	94	2x12 Class-A 30w Silver Mix	132	4x12 Citrus V30 (V9)
19	2x12 Black	57	4x12 SLM H75 (OH)	95	2x12 Supremo Mix		
20	2x12 Brit	58	4x12 SLM M75 (OH)	96	2x12 Santiago EJ1250 Mix		
21	2x12 Doubleverb D120 (RW)	59	4x12 SLM V30 (OH)	97	2x12 Santiago Altec Mix		
22	2x12 Doubleverb C12N (RW)	60	4x12 20w	98	3x10 Vibrato King Mix		
23	2x12 Blue	61	4x12 25w	99	4x10 Bassguy Mix		
24	2x12 Top Boost Blue (RW)	62	4x12 V30	100	4x10 Super Verb Mix		
25	2x12 Top Boost Silver (RW)	63	4x12 German	101	4x12 Basketweave Green Mix		
26	2x12 Boutique (RW)	64	4x12 30w (Ultra)	102	4x12 Basketweave AX Mix		
27	2x12 Jazz (RW)	65	4x12 Cali	103	4x12 Basketweave TV Mix		
28	2x12 Gold 30 Far-Field (JM)	66	1x15 L.A. Bass	104	4x12 Cali Lead 80s Mix		
29	2x12 G12-65 Far-Field (JM)	67	4x10 Aluminum Bass (RW)	105	4x12 Rumble EV12L Mix		
30	2x12 Boutique	68	8x10 SV Bass (RW)	106	4x12 Rumble EV12S Mix		
31	2x12 Doubleshow (RW)	69	4x12 V30 #1 (Kalthallen)	107	4x12 PVH6160 Mix		
32	4x10 Tweed Bass	70	4x12 V30 #2 (Kalthallen)	108	4x12 Petrucci V30 Mix		
33	4x10 Bassguy P10 (RW)	71	4x12 V30 #3 (Kalthallen)	109	1x15 SV Bass M88 Mix		
34	4x12 Basketweave G12H30 (RW)	72	4x12 V30 #4 (Kalthallen)	110	1x15 SV Bass Subkick Mix		
35	4x12 Basketweave G12L (RW)	73	4x12 G12T75 #1 (Kalthallen)	111	4x10 SV Bass M88 Mix		
36	4x12 Basketweave G12M20 (RW)	74	4x12 G12T75 #2 (Kalthallen)	112	4x10 SV Bass Subkick Mix		
37	4x12 Basketweave G12M25 (RW)	75	1x8 Champlier Mix	113	4x10+Tweeter SV Bass M88 Mix		
38	4x12 1960A G12M (RW)	76	1x8 Vibrato Champlier Mix	114	1x12 AC-20 Dlx Mix		

Blue and red indicate multiple firmware versions of the same cab. Magenta cabs are far field IRs.

<u>AXE-FX AMP</u>	<u>BASED ON</u>	<u>DESCRIPTION</u>
1987X Jump	Marshall 1987x Vintage Series	Reissue of the 50w JMP Lead 1987. Features an “essential” mod to the tonestack of this Plexi. Emulates “jumpering the inputs” on a 4-hole amp.
1987X Normal	Marshall 1987x Vintage Series	Normal channel.
1987X Treble	Marshall 1987x Vintage Series	Treble channel.
5153 Blue	EVH 5150 III (Blue)	Blue (rhythm) channel of the 100w 6L6 model, made in collaboration with Fender. Recommended settings.
5153 Green	EVH 5150 III (Green)	Green (clean) channel.
5153 Red	EVH 5150 III (Red)	Red (high gain/lead) channel.
59 Bassguy	Fender Bassman	1959, Tweed era, 5F6-A circuit. Low-to-medium gain amp designed for bass but widely adopted by guitarists.
5F1 Tweed	Fender Champ	5F1 circuit (‘58-‘64), single-ended, Class A, 5w. This particular amp exhibits a unique breakup characteristic due to its single-ended design and simple circuit.
65 Bassguy	Fender Bassman	1965 Blackface version, AB165 circuit which is very crunchy and bright and does not sound like a typical Fender.
AC-20 Dlx Bass	Morgan AC20 Deluxe	Based around the normal channel of a Vox AC30 and voiced intentionally to be on the dark side. EL84. Normal/Brilliant switch = Normal. Bright OFF + treble booster = Brian May, Bright ON = U2.
AC-20 Dlx Treb	Morgan AC20 Deluxe	Normal/Brilliant switch = Brilliant.
Angle Severe 1	ENGL Savage 120	Rough channel. Contour = OFF: boosts lower midrange around 500 Hz (warm tone.)
Angle Severe 2	ENGL Savage 120	Contour ON: boosts from 1200 Hz and cuts lower midrange (more transparency.)
Atomica High	Cameron Atomica	A “brown sound” 100w amp, high gain channel.
Atomica Low	Cameron Atomica	Low gain channel.
Band Commander	Fender Bandmaster	1968 Silverface Fender Bandmaster with the AB763 circuit.
Big Hair	80’s metal	Mids without mud. Revive the 80s metal scene. (Spandex not included.)
Blanknshp Leeds	Blankenship Leeds 21	EL84 tubes. Boutique version of an 18w Marshall with a big sound at low power. Mercury Magnetics transformers.
Bludojai Clean	Bludotone Ojai (Clean)	Reported to be an exact clone of Robben Ford’s Tan Dumble. Clean mode modeled with preamp boost (PAB) engaged as the owner prefers this. To disengage PAB change the tonestack type to Skyline.
Bludojai Lead	Bludotone Ojai (Lead)	Lead mode.
Bogfish Brown	Bogner Fish preamp	Blue 4-channel tube preamp. Brown = fat high gain.
Bogfish Strato	Bogner Fish preamp	Strato = tight high gain.
Boutique 1	Matchless Chieftain	Medium-gain amp, thick, yet crisp, with a fair amount of power amp breakup. Based on a Vox circuit.
Boutique 2	Matchless Chieftain	Added Boost for more gain and high-frequency emphasis.
Brit 800	Marshall JCM800	Model 2204. Bring the Master up for true 80’s tone. To soften the attack, lower Triode Freq and increase Damping.
Brit 800 Mod	modded Marshall JCM800	Removed the treble peaker, making the amp “heavier” and “less strident”.
Brit Brown	Van Halen’s Marshall	Faithful recreation of the legendary “Brown Sound” – The modded “#1” Marshall.
Brit JM45	Marshall JTM45 (Ch 1)	Made famous by Clapton and others; a modified Bassman design. Try with a Tonebender or Treble Booster.
Brit JM45 Jump	Marshall JTM45 (Ch 1)	Emulates “jumpering the inputs” on a 4-hole amp.
Brit JVM OD1 Gn	Marshall JVM410 (OD1, Green)	OD1 channel, Green mode, hot-rodded.
Brit JVM OD1 Or	Marshall JVM410 (OD1, Orange)	OD1 channel, Orange mode, extra gain. For Red mode, enable Boost or increase the Input Trim parameter.
Brit JVM OD2 Gn	Marshall JVM410 (OD2, Green)	OD2 channel, Green mode, lower mids than OD1.
Brit JVM OD2 Or	Marshall JVM410 (OD2, Orange)	OD2 channel, Orange mode, more gain and lower mids than OD1. See above for Red mode.
Brit Pre	Marshall JMP-1	Rack-mount preamplifier version of the Brit 800. OD2 channel. Crunchy “ZZ” tone.
Brit Silver	Marshall Silver Jubilee	100w Marshall Silver Jubilee (2555), commemorative “25/50” model. Slightly darker and higher gain than JCM800.
Brit Super	Marshall AFD100	100w dual-mode head with 6550 tubes, believed to be a modified 1959 Tremolo. Used by Slash on “Appetite for Destruction”. AFD mode adds an extra gain stage, 34 mode is based on Slash’s modded JCM 800 (2203).
Buttery	Budda Twinmaster	Based loosely on a late 90’s specimen. Relies mostly on power amp distortion.
CA3+ Clean	CAE 3+ SE preamp (Ch 1)	Custom Audio Electronics preamp. The Clean channel is based on a Blackface Fender preamp.

Red amps are non-MV (no Master Volume on the real amp). The MASTER VOL is set to 10 by default.

⚡ Includes the additional OVERDRIVE control.

🌀 The actual amp has a control labeled “Tone” which corresponds to TREB on the Axe-Fx. For a more realistic simulation, leave BASS and MID at noon.

⌘ Amps with no negative feedback, created by setting DAMPING to zero. PRESENCE is replaced with HI CUT. DEPTH is also disabled since it only affects negative feedback.

AXE-FX AMP	BASED ON	DESCRIPTION
CA3+ Lead	CAE 3+ SE preamp (Ch 3)	Channel 3 (Lead). The CAE 3+ SE is basically an OD-100.
CA3+ Rhy	CAE 3+ SE preamp (Ch 2)	Channel 2 (Rhythm).
Cali Leggy	Carvin Legacy VL100	Legacy 1, 100w, EL34. Uses a "James" tone stack which is more like hi-fi tone controls. Based on Steve Vai's original signature Legacy amplifier. To get a Steve Vai tone, keep Treble low, Bass high and not too much Gain.
Cameron Ch 1	Cameron CCV100 (Ch 1)	An amp its creator Mark Cameron calls "one pissed off amp"
Cameron Ch 2	Cameron CCV100 (Ch 2)	Higher gain tone. On Channel 2, Saturation is engaged by default, no Presence (set it to 0).
Car Roamer ☞	Carr Rambler	Basically a Deluxe Reverb preamp with cathode bias 6L6 power amp and no negative feedback. Fender-meets-Vox. On the actual amp, a toggle switch engages either the 28w pentode or 14w triode.
Carolann OD-2 †	Carol-Ann OD-2r	50W, EL34 or 6L6 tubes. Overdrive channel. Model fine-tuned by the highly respected Alan Phillips.
Citrus A30 Cln ☞	Orange AD30HTC (Clean)	30w tube head, Clean channel.
Citrus A30 Drty ☞	Orange AD30HTC (Dirty)	30w tube head, Dirty channel.
Citrus Bass 200	Orange AD200B	200w valve bass head, 6550 tubes.
Citrus RV50	Orange Rockerverb	"Dirty" channel of the 50w head known for warmth and rich harmonics.
Citrus Terrier ☞	Orange Tiny Terror	7w or 15w, EL84 tubes. The actual amp has no tone stack (neutral in Axe-Fx) and a single Hi-Cut tone control.
Class-A 15w TB ☞	Vox AC-15 Top Boost	15w, EL84 tubes. The heart of this amp's tone comes from its power section and no negative feedback.
Class-A 30w ☞	Vox AC-30	30w, EL84 tubes. Combo that dominated the British Invasion. Gritty character, warm tone, great feel. For authentic tone, leave the tone controls at noon and use Hi-Cut to cut treble
Class-A 30w TB ☞	Vox AC-30 Top Boost	30w, EL84 tubes. Created in response to demand for "more treble". Great highs and slightly reduced bass.
Comet 60	Komet 60	EL34 tubes.
Comet Concourse	Komet Concorde	EL34 tubes. Similar to Trainwreck amp. Response switch = "Fast". To replicate "Slow" reduce INPUT TRIM to 0.25"
Corncob M50 †	Cornford MK50 II	Boutique British amp. Plexi-meets-modern tone with big cojones.
Das Metall	Diezel VH4 (Ch 4)	EL34 or 6L6 tubes. High-gain, boutique amp famous for its powerful, heavy, aggressive sound. See <i>Dizzy V4 4</i> .
Deluxe Tweed ☞	Fender Tweed Deluxe	Fender Deluxe (5E3) from the 50's, 15w. The earliest and most popular of the so-called Tweed amplifiers.
Deluxe Verb	Fender Deluxe Reverb	1965 Blackface, 22w, AB763 circuit. Great, chimy tone with nice power amp breakup.
Dirty Shirley	Friedman Dirty Shirley	40w, 6L6. Designed to be an ultra-fat, sweet-sounding, classic rock amp. Based on a JTM45.
Div/13 CJ ☞	Divided by 13 CJ 11	11w, bassy amp, works best with single coils. High-performing "Tweed" meets "EL34" meets "Master Vol" 1x12.
Div/13 FT37 Hi ☞	Divided by 13 FTR 37	Divided by 13 FTR 37, 37w, Class-AB, two channels, 6V6 tubes. Gain Boost ON.
Div/13 FT37 Lo ☞	Divided by 13 FTR 37	Gain Boost OFF.
Dizzy V4 2	Diezel VH4 (Ch 2)	High-gain boutique amp with heavy, aggressive sound. 6550, EL34 or 6L6. Channel 2, "gritty funk, dynamic clean"
Dizzy V4 3	Diezel VH4 (Ch 3)	Channel 3, the favorite channel for most users, with higher gain but still big dynamic range.
Dizzy V4 4	Diezel VH4 (Ch 4)	Channel 4, newer version of <i>Das Metall</i> . A monster of gain which still has great definition and authority.
Double Verb	Fender Twin Reverb	100w, 1966 Blackface, AB763 circuit. Known for amazing clean sounds and nice breakup.
Energyball	ENGL Powerball	100w Lead channel, 6L6 tubes. Very high-gain German model. Lots of bass. Great for aggressive, drop-tuned riffs.
Euro Blue	Bogner Ecstasy (Blue)	20th Anniv. model. Dark amp, turn up Presence or engage Bright. Blue channel, Structure switch = 'V' (Vintage).
Euro Blue Mdrn	Bogner Ecstasy (Blue)	Blue channel, Structure switch = 'M' (Modern).
Euro Red	Bogner Ecstasy (Red)	Red channel, Structure switch = 'V' (Vintage).
Euro Red Mdrn	Bogner Ecstasy (Red)	Red channel, Structure switch = 'M' (Modern).
Euro Uber	Bogner Überschall	120w, EL34. High Gain channel. Heavy grinding lows and insane gain. Sweep Presence for a wide variety of tones.
FAS 6160	Peavey EVH 5150	Alternative version of the PVH 6160, more open and less fizzy than the original amp. Also, a virtual choke has replaced the resistor found on the original's power supply filter. This results in a bouncier feel.
FAS Bass	n/a	Custom Fractal bass model. This amp uses an active tone stack so the Fat switch will have no effect.
FAS Brootalz	ENGL Savage 120 / SLO 100	ENGL Savage model with the input stage (and possibly power amp) from an SLO100.
FAS Brown	Van Halen's Marshall	Original BROWN model from the Axe-Fx Standard/Ultra.

Red amps are non-MV (no Master Volume on the real amp). The MASTER VOL is set to 10 by default.

† Includes the additional OVERDRIVE control.

☞ The actual amp has a control labeled "Tone" which corresponds to TREB on the Axe-Fx. For a more realistic simulation, leave BASS and MID at noon.

☞ Amps with no negative feedback, created by setting DAMPING to zero. PRESENCE is replaced with HI CUT. DEPTH is also disabled since it only affects negative feedback.

<u>AXE-FX AMP</u>	<u>BASED ON</u>	<u>DESCRIPTION</u>
FAS Class-A ☹	Carr Rambler	A "Blackface" preamp into a cathode-biased 6L6 power amp with no negative feedback. This was a happy accident when originally modeling the Carr Rambler in the beta version of firmware v12.03.
FAS Crunch	ultimate British amp	More dynamic and open than a Plexi, but with more gain.
FAS Lead 1	Mesa Boogie TriAxis (presumed)	Neutral high-gain lead with a tight midrange.
FAS Lead 2	Mesa Boogie TriAxis (presumed)	Hot-rodded British lead sound with a tonestack by Bob Bradshaw (Custom Audio Electronics).
FAS Modern	high gain rhythm + lead hybrid	High-gain hybrid. Equally well-suited to modern rhythm or lead work. Loosely based on a Recto with tighter bass.
FAS Modern II	high gain rhythm + lead hybrid	Tighter version of the popular FAS Modern model with a 5150-style bass boost in the tone stack.
FAS Rhythm	British + USA crunch	Combines the best features of the British and USA crunch models.
FAS Wreck	Trainwreck Express	Original WRECKER 1 model from the Axe-Fx Ultra.
Fox ODS I ⚡	Fuchs Overdrive Supreme-50	Overdrive channel, 50w, 6L6 tubes. Mid switch ON.
Fox ODS II ⚡	Fuchs Overdrive Supreme-50	Mid switch OFF.
Friedman BE	Friedman Brown Eye	50w or 100w, EL34. What many call "the ultimate modded Plexi" by Dave Friedman (Rack Systems).
Friedman HBE	Friedman Hairy Brown Eye	BE amp's alternate voicing with a gain boost. A killer hi-gain tone in your arsenal.
Fryette D60 L ⚡	Fryette D60 (Less)	60w, KT88 or 6550 tubes. "Deliverance Sixty". "Less" mode.
Fryette D60 M ⚡	Fryette D60 (More)	"More" mode.
Gibtone Scout ☹	Gibson Scout	1964 GA17RVT Scout, 17w, vintage clean tones. No tone controls on the real amp.
Herbie Ch2+	Diezel Herbert (Ch 2+)	3-channel 180w, called "looser" and "more "familiar" than the VH4. Channel 2+ gets you into Diezel VH4 territory.
Herbie Ch2-	Diezel Herbert (Ch 2-)	Set Ch 2- at 35% gain for a cranked Plexi tone, 60% for a JCM800 tone.
Herbie Ch3	Diezel Herbert (Ch 3)	Channel 3.
Hipower Brillnt.	Hiwatt DR103 (Brilliant)	1974 Harry Joyce/Hylight model. Medium-gain, full sound with unique tone-stack and chimey, grinding tone.
Hipower Jumped	Hiwatt DR103 (Normal/Brilliant)	Emulates "jumpering the inputs" on a 4-hole amp.
Hipower Normal	Hiwatt DR103 (Normal)	Normal channel.
Hot Kitty ☹	Bad Cat Hot Cat 30r (Ch 2)	30w, EL34, cathode bias, Channel 2. Voted by Guitar Player as "the second best combo of all time."
Jazz 120	Roland JC-120	120w (stereo: 2x 60w). The only solid-state-based model in the collection, a quintessential clean tone.
JR Blues	Fender Blues Jr.	15w. A gutsy little classic with dual EL84s. To get the tone of an Egnater Rebel 20, set the Damping to zero.
Matchbox D-30 ☹	Matchless DC-30	Matchless DC-30, 30w, Class-A, EL84s. A "better sounding" AC-30.
Mr Z MZ-38 ☹	Dr. Z MAZ 38 SR	38w, EL84 tubes. Popular with country and roots players. The quintessential country amp.
Mr Z MZ-8 ☹	Dr. Z MAZ 8	8w, EL84 tube. A popular low-wattage, single-ended amp. The actual amp can be run in Pentode or Triode mode.
Nuclear-Tone ☹	Swart Atomic Space Tone	20w, 6V6. As with the actual amp, the bias tremolo is particularly effective.
ODS-100 Clean	Dumble OD Special (Clean)	100w "HRM" (Hot Rod Marshall) version, Clean channel. A coveted but rare amp made famous by Robben Ford.
ODS-100 Ld Mid ⚡	Dumble OD Special (OD)	Lead channel with the "Mid" switch engaged (this switch is sometimes labeled "Deep").
ODS-100 Lead ⚡	Dumble OD Special (OD)	Lead channel matched with the preamp bypass (PAB) engaged (which bypasses the input tone stack) and the Drive control at approximately 7.0. Played by the great Larry Carlton and many others!
ODS-100 Lead 2 ⚡	Dumble OD Special (OD)	"Non-HRM" version. Preamp Bypass ON. The default tone stack is neutral (with B/M/T at noon the response is flat.)
ODS-100 Lead 3 ⚡	Dumble OD Special (OD)	"Non-HRM" version. Preamp Bypass OFF.
Plexi 100w High	Marshall Super Lead 1959	1968 model. Classic amp head that gave rise to "the stack." Great for crunchy rhythm work. As with the real amp, don't be afraid to turn the bass all the way down or the treble all the way up, or it's too flubby. Treble channel.
Plexi 100w Jump	Marshall Super Lead 1959	Emulates "jumpering the inputs" on a 4-hole amp.
Plexi 100w Nrml	Marshall Super Lead 1959	Normal channel.
Plexi 50w High	Marshall Super Lead 1959	1972 model. Treble channel.
Plexi 50w Jump	Marshall Super Lead 1959	Emulates "jumpering the inputs" on a 4-hole amp.
Plexi 50w Nrml	Marshall Super Lead 1959	Normal channel.
Prince Tone ☹	Fender Princeton (Tweed)	Class A, 5w. 5F2-A, AA964 circuits. Modeled after early CBS "Silverface" model, pre-CBS design and components.

Red amps are non-MV (no Master Volume on the real amp). The MASTER VOL is set to 10 by default.

⚡ Includes the additional OVERDRIVE control.

☹ The actual amp has a control labeled "Tone" which corresponds to TREB on the Axe-Fx. For a more realistic simulation, leave BASS and MID at noon.

☹ Amps with no negative feedback, created by setting DAMPING to zero. PRESENCE is replaced with HI CUT. DEPTH is also disabled since it only affects negative feedback.

<u>AXE-FX AMP</u>	<u>BASED ON</u>	<u>DESCRIPTION</u>
Prince Tone NR ☉	Fender Princeton (no reverb)	No reverb.
Prince Tone Rev ☉	Fender Princeton (reverb)	1966 reverb.
PVH 6160 Block	Peavey EVH 5150 (Lead)	120w, 6L6. Rematched against an original block letter Peavey EVH 5150. Lead channel.
PVH 6160 II	Peavey 6505+	120w, 6L6. Identical to the EVH II.
Recto1 Org Mdrn ☹	Mesa Boogie 2 ch. Dual Rectifier	Orange channel, Modern mode. Presence control now operates like the actual amp in all Recto models. <i>For those models where there is no negative feedback, the Presence control is part of the tone stack (not a Hi Cut control).</i>
Recto1 Org Norm	Mesa Boogie 2 ch. Dual Rectifier	Orange channel, Normal mode. Warmer and less fizzy than the 3 channel model.
Recto1 Red Mdrn ☹	Mesa Boogie 2 ch. Dual Rectifier	Red channel, Modern mode.
Recto2 Org Mdrn ☹	Mesa Boogie 3 ch. Dual Rectifier	Orange channel, Modern mode.
Recto2 Org Vint	Mesa Boogie 3 ch. Dual Rectifier	Orange channel, Vintage mode.
Recto2 Red Mdrn ☹	Mesa Boogie 3 ch. Dual Rectifier	Red channel, Modern mode.
Recto2 Red Vntg	Mesa Boogie 3 ch. Dual Rectifier	Red channel, Vintage mode.
Ruby Rocket ☹	Paul Ruby Rocket	Trainwreck Rocket clone (similar to a Vox).
Shiver Cln.	Bogner Shiva (Clean)	90w, KT88. 20th anniv. Clean channel, powerful shimmering cleans. Dark amp, turn up Presence or engage Bright.
Shiver Ld	Bogner Shiva (Lead)	Lead channel, sweet, rich-sounding amp with aggressive, English-style midrange punch.
Solo 100 Clean	Soldano SLO-100 (Nrml/Clean)	SLO = Super Lead Overdrive, 100w. Normal channel, Clean gain selector.
Solo 100 Lead	Soldano SLO-100 (Lead)	Snarling Lead channel. The SLO -100 likes to be run hard, so the Master Volume defaults to a higher setting than on most other amps. To achieve the best sound, also back off the preamp gain.
Solo 100 Rhy.	Soldano SLO-100 (Nrml/Crunch)	Normal channel, Crunch gain selector. Aggressive rhythm.
Solo 88 Rhythm	Soldano X88R preamp (Crunch)	Crunch channel of the Soldano X88R 3-channel preamp.
Solo 99 Clean	Soldano X99 preamp (Clean)	Soldano/Caswell midi-motorized X99 preamp; Clean channel.
Solo 99 Lead	Soldano X99 preamp (Lead)	Lead channel.
Spawn Nitrous	Splawn Nitro (OD)	100w, KT-88, OD channel. Splawn tone with more saturation and voiced for a bigger low end and low mids.
Spawn Q-Rod 1st	Splawn Quick Rod (1st gear)	100w, Ch 2. Signature Splawn tone with lots of bite, strong mids and 3 gear versatility. 1st gear, "Hot Rod Plexi".
Spawn Q-Rod 2nd	Splawn Quick Rod (2nd gear)	2nd gear, "Hot Rod JCM 800".
Spawn Q-Rod 3rd	Splawn Quick Rod (3rd gear)	3rd gear, "Super Hot Rod 800".
Suhr Badger 18 ☹	Suhr Badger 18w	18w version of this EL84-powered tube rectifier classic. Master Volume is VERY powerful at altering the tone.
Suhr Badger 30 ☹	Suhr Badger 30w	In comparison to the 18w, the 30w features a solid state rectifier.
Super Verb	Fender Super Reverb	Pre-CBS 1964 Blackface version of this 40w amp, AB763 circuit, Vibrato channel.
Supertweed	Fender Tweed series	Original SUPERTWEED model from the Axe-Fx Ultra. "Like a vintage Tweed amplifier on steroids."
Supremo Trem ☉☹	Supro 1964T	Supro 1964T.
SV Bass	Ampeg SVT	300w, Super Vacuum Tube bass amp. Used for decades by famous bassists the world over.
Thordendal Mdrn ☹	n/a	Based on Fredrik Thordendal's specifications.
Thordendal Vint	n/a	Based on Fredrik Thordendal's specifications.
Tremolo Lux	Fender AA763 Tremolux	6L6, high and low inputs, Normal and Vibrato channels.
Trip-Tik Classic ☩	Carol-Ann Triptik (Classic)	50w, EL34. Classic channel: A little less gain and low end. Produces 70's and 80's British rock tones with a very wide and complex sound stage with no buzz or brittle high frequencies.
Trip-Tik Clean	Carol-Ann Triptik (Clean)	Clean channel.
Trip-Tik Modern ☩	Carol-Ann Triptik (Modern)	Modern channel: More gain and low end for those more modern heavy rhythm, dropped tunings. Also makes for a superb liquid lead channel with incredible sustain and harmonic bloom.
Tube Pre ☹	generic tube preamp	Completely neutral, low-gain tube preamp useful for "warming up" various sources.
Two Stone J35 1 ☩	Two-Rock Jet 35	35w, 6L6. Lead mode, Preamp Bypass ON, which bypasses the input tone stack for a more focused lead sound.
Two Stone J35 2 ☩	Two-Rock Jet 35	Lead mode, Preamp Bypass OFF.

Red amps are non-MV (no Master Volume on the real amp). The MASTER VOL is set to 10 by default.

☩ Includes the additional OVERDRIVE control.

☉ The actual amp has a control labeled "Tone" which corresponds to TREB on the Axe-Fx. For a more realistic simulation, leave BASS and MID at noon.

☹ Amps with no negative feedback, created by setting DAMPING to zero. PRESENCE is replaced with HI CUT. DEPTH is also disabled since it only affects negative feedback.

<u>AXE-FX AMP</u>	<u>BASED ON</u>	<u>DESCRIPTION</u>
TX Star Clean	Mesa Lone Star (Clean)	Clean channel, 50/100w, 6L6. Try with a BB Pre drive block.
TX Star Lead †	Mesa Lone Star (Lead)	Lead channel.
USA Bass 400 1.	Mesa Bass 400	Bass Shift OFF.
USA Bass 400 2.	Mesa Bass 400	Bass Shift ON.
USA Clean 1	Mesa Boogie MKIV (Rhy 1)	Somewhat neutral, clean-sounding model that can pushed into warm clipping. Rhythm 1 channel.
USA Clean 2	Mesa Boogie TriAxis preamp.	Rhythm Green channel ("Vintage Fat Rhythm" or "old Black Face").
USA IIC+ Bright †	Mesa B. Mark IIC+ (Lead)	Bright ON.
USA IIC+ Norm †	Mesa B. Mark IIC+ (Lead)	US-made amp famous for its smooth overdrive sound; Bright OFF.
USA Lead †	Mesa Boogie MKIV (Lead)	Tight, focused, hi-gain sound. Great for fusion and rock leads. Bright OFF, Mid Gain OFF.
USA Lead + †	Mesa Boogie MKIV (Lead)	Bright OFF, Mid Gain ON.
USA Lead Brt †	Mesa Boogie MKIV (Lead)	Bright ON, Mid Gain OFF.
USA Lead Brt + †	Mesa Boogie MKIV (Lead)	Bright ON, Mid Gain ON.
USA Pre Ld1 Red †	Mesa Boogie TriAxis preamp.	Lead 1 Red mode (TX-4 board.)
USA Pre Ld2 Grn †	Mesa Boogie TriAxis preamp.	Lead 2 Green mode (Mid Gain Mark IV Lead.)
USA Pre Ld2 Red †	Mesa Boogie TriAxis preamp.	Lead 2 Red mode (shred.)
USA Pre Ld2 Ylw †	Mesa Boogie TriAxis preamp.	Lead 2 Yellow mode (Classic MKII Lead.)
USA Rhythm	Mesa Boogie MKIV (Rhy 2)	THE California crunch rhythm sound. Rhythm Channel 2 with Fat switch OFF.
USA Sub Blues	Mesa Subway Blues	20w, EL84.
Vibrato Lux	Fender VibroLux Reverb	1963 Blackface model, 6L6.
Vibrato Verb	Fender Vibroverb	40w combo that's great for clear or grinding cleans and gutsy blues. 6G16 circuit, Brownface era.
Vibrato-King ⌘	Fender Vibro-King	Fender Vibro-King, famous for crystal cleans and powerful overdrive. Modeled with the Fat switch ON.
Wrecker 1	Trainwreck Express	Trainwreck Express, designed and built by the late, great Ken Fischer.
Wrecker 2	Trainwreck Express	Based on a real Trainwreck.
Wrecker Lvrpool	Trainwreck Liverpool	Basically a Trainwreck Express preamp with a Trainwreck Rocket power amp. EL84 tubes.

Red amps are non-MV (no Master Volume on the real amp). The MASTER VOL is set to 10 by default.

† Includes the additional OVERDRIVE control.

⊗ The actual amp has a control labeled "Tone" which corresponds to TREB on the Axe-Fx. For a more realistic simulation, leave BASS and MID at noon.

⌘ Amps with no negative feedback, created by setting DAMPING to zero. PRESENCE is replaced with HI CUT. DEPTH is also disabled since it only affects negative feedback.

<u>AXE-FX CAB</u>	<u>DESCRIPTION</u>
1	1x6 Oval6" Supro, 6x9 oval speaker used in some early amps (Supro). Combine with a Plexi for some Zep.
2	1x8 Tweed1x8 Fender Blues Jr. Really thin and cutting for roots blues leads.
3	1x10 Gold1x10 Chicago Jensen C10N
4	1x10 Blue1x10 Alnico Blue
5	1x12 TweedFender 1x12 Tweed, based on the original 12" speaker used in an early Fender "Tweed".
6	1x12 BlackFender Blackface 1x12
7	1x12 BlueVox 1x12
8	1x12 E12L (RW)200w Electro-Voice EVM-12L, housed in a solid mahogany, open-backed cabinet. Firmware 9 version at cabinet 119.
9	1x12 StudioMesa Studio 22 1x12
10	1x12 EMI Open Back (JM)Far field IR (Eminence).
11	1x12 Boogafunk Blue (OH)Boogafunk Thiele 1x12 with Celestion Alnico Blue.
12	1x12 Boogafunk E12L (OH)Boogafunk Thiele 1x12 with Electro Voice EVM-12L Classic.
13	1x12 Tweed Blue (RW)Tweed Deluxe narrow panel from 1956 with replacement Celestion Alnico Blue speaker for brighter tone with more high end sparkle.
14	1x12 Tweed Deluxe (RW)Tweed Deluxe narrow panel from 1956 with the original Jensen P12R speaker for the purists. Rounder, warmer sound than the Blue.
15	1x12 Brit Blue (RW)Celestion Alnico Blue 12", IR of the speaker without a cabinet.
16	1x12 Brit G12H30 (RW)Celestion G12H30", IR of the speaker without a cabinet. Firmware 9 version at cabinet 120.
17	1x15 BluesPeavey Delta Blues 1x15
18	1x15 Thunderbolt (RW)Supro Thunderbolt S6420 cabinet with the original 15" Jensen speaker. Probably a Red Wirez IR. Decent low end for a small, open-backed cabinet, a boost around 550Hz that gives it some mid range "honk", and crunchy upper mids.
19	2x12 BlackFender Deluxe/Twin Reverb 2x12
20	2x12 BritVox AC30 with 2x12 Alnico Blue speakers.
21	2x12 Doubleverb D120 (RW)67 Fender Twin Reverb cabinet with vintage JBL D120Fs. The D120s have more low end than the C12Ns and a peak around 3700 Hz, for distinctly edgier upper mids. Firmware 9 version at cabinet 121.
22	2x12 Doubleverb C12N (RW)67 Fender Twin Reverb cabinet with vintage Jensen C12Ns. A little less bass than the D120s and a peak around 2500Hz which gives it a crunchier sound than the JBLs. Firmware 9 version at cabinet 122.
23	2x12 BlueChicago Jensen P12Q, two classic American 12" speakers with blue labels.
24	2x12 Top Boost Blue (RW)Vox AC30 with two Vox labeled Celestion Alnico Blues made in the UK. Chimey Vox goodness.
25	2x12 Top Boost Silver (RW)Vox AC30 with two Vox labeled alnico, silver speakers. These are 25 wattish, T1656 frame, Alnico silvers with Pulsonic cones made for the Thomas Organ Company in the 60's. Slightly less extended upper mids than the blues, same cones as the early greenbacks. Cool speakers in pristine condition.
26	2x12 Boutique (RW)Matchless ES212, with one custom voiced 30w Celestion G12H and one 25w Celestion G12M.
27	2x12 Jazz (RW)Roland Jazz Chorus JC-120 with Roland 12" speakers. Clean, kinda like a more scooped JBL D120.
28	2x12 Gold 30 Far-Field (JM)Far field IR of a Celestion Alnico Gold.
29	2x12 G12-65 Far-Field (JM)Far field IR of a Celestion G12-65.
30	2x12 BoutiqueMatchless 2x12
31	2x12 Doubleshow (RW)Fender Dual Showman cabinet with vintage JBL D130s. Firmware 9 version at cabinet 123.
32	4x10 Tweed BassFender 4x10 Bassman
33	4x10 Bassguy P10 (RW)Reproduction Narrow Panel Tweed Bassman cabinet with vintage '57 Jensen P10Qs. Crunchy upper mids, scooped low mids, and tons of low end below 70Hz.
34	4x12 Basketweave G12H30 (RW) ...68 Marshall Basketweave 4x12 with a matched quad of vintage, 30w, Celestion G12H "blackbacks." T1281 frames and "444", 55Hz bass cones from the late 70's. Unleash your inner Jimi, or Jimmy, if you prefer. Firmware 9 version at cabinet 124.
35	4x12 Basketweave G12L (RW)68 Marshall Basketweave 4x12 with vintage Celestion G12Ls.
36	4x12 Basketweave G12M20 (RW) ..68 Marshall Basketweave 4x12 with 20w Celestion Heritage G12Ms. Brown sound all around.
37	4x12 Basketweave G12M25 (RW) ..68 Marshall Basketweave 4x12 with vintage Marshall labeled 25w Celestion G12Ms. These beauties have T1221 frames and Pulsonic 003 "lead" cones.
38	4x12 1960A G12M (RW)Slant Marshall 1960 with four 25w Celestion G12Ms, aka "Greenbacks".

In Firmware 10 many of the factory cabs were remixed so as to sound more "in the room". The (V9) cabs have a more "studio-polished sound". Far field IRs: cabs 10, 28 and 29.

<u>AXE-FX CAB</u>	<u>DESCRIPTION</u>
39	4x12 1960B T75 (RW)Straight Marshall 1960 with four Celestion G12T 75s.
40	4x12 1960B K120 (RW)Marshall 1960 cabinet with JBL K120s.
41	4x12 1960B V30 (RW)Straight Marshall 1960 with four Celestion Vintage 30s. Firmware 9 version at cabinet 125.
42	4x12 Hi-Power (RW)1975 Hiwatt SE4123 cabinet with four vintage 50w Fane purplebacks.
43	4x12 Recto V30 (RW)Oversized Mesa Rectifier cabinet with four Celestion Vintage 30s. Firmware 9 version at cabinet 126.
44	4x12 Recto V30 (OH)Mesa Boogie Rectifier 4x12 with Celestion Vintage 30s.
45	4x12 Solo V12 (RW)Soldano 412B with four Eminence Legend V12s. A lot more high end than the S12X version. It's a front-loaded cab with lots of resonance so you may need to back the mics off a bit more than usual.
46	4x12 Solo S12X (RW)Soldano 412B with four Eminence made S12Xs. S12Xs were stock in the older cabs. Give this one a little more distance than you might normally, the cab resonance is pronounced up close and the speakers have a notch in the upper mids between 4-8KHz. Nice for taming fizzy guitars.
47	4x12 German V30 (RW)Bogner or ENGL Pro 4x12 cabinet with four Celestion Vintage 30s. Firmware 9 version at cabinet 127.
48	4x12 German Boutique (RW)ENGL Pro 4x12 cabinet with four Celestion Vintage 30s.
49	4x12 PVH6160 (RW)Older model Peavey 5150 4x12 cabinet with four Sheffield 1200 speakers. Firmware 9 version at cabinet 128.
50	4x12 Uber T75 (RW)Bogner Uberkab, with Celestion G12T 75s + Vintage 30s. This IR features the T-75s. Firmware 9 version at cabinet 129.
51	4x12 Uber V30 (RW)Same as above. This IR features the V30s. Firmware 9 version at cabinet 130.
52	4x12 Uber T75+V30 (RW)Same as above. This IR is a 50/50 mix of both speakers. Firmware 9 version at cabinet 131.
53	4x12 Citrus V30 (RW)Straight Orange 4x12 (PPC412) with Celestion Vintage 30s. Firmware 9 version at cabinet 132.
54	4x12 Mills 12K (OH)Mills Acoustics Afterburner 4x12 with Celestion G12K-100 speakers.
55	4x12 SLM Blue (OH)SLM Electronics 4x12 with Celestion Alnico Blue speakers.
56	4x12 SLM G65 (OH)SLM Electronics 4x12 with Celestion Heritage G12-65 speakers.
57	4x12 SLM H75 (OH)SLM Electronics 4x12 with Scumback H75 speakers, similar to G12.
58	4x12 SLM M75 (OH)SLM Electronics 4x12 with Scumback M75 speakers, similar to 1987 G12M (greenback).
59	4x12 SLM V30 (OH)SLM Electronics 4x12 with Celestion Vintage 30 speakers.
60	4x12 20wMarshall with 4x12 low power 20w Greenbacks.
61	4x12 25wMarshall with 4x12 25w Greenbacks, 1970's.
62	4x12 V30Generic 4x12 with Celestion V30 speakers.
63	4x12 GermanBogner 4x12
64	4x12 30w (Ultra)G12H30 from the Axe-Fx Ultra (previously in this slot: 4x12 Metal, an Engl 4x12 captured by Jocke Skog of the band Clawfinger).
65	4x12 CaliMesa Boogie traditional 4x12
66	1x15 L.A. BassSWR 1x15 bass amp cabinet
67	4x10 Aluminum Bass (RW)Hartke 4x10" bass cabinet with aluminum drivers.
68	8x10 SV Bass (RW)Ampeg SVT 810 Bass cab with stock SVT 10" speakers.
69	4x12 V30 #1 (Kalthallen)4x12 with Celestion V30 speakers.
70	4x12 V30 #2 (Kalthallen)4x12 with Celestion V30 speakers.
71	4x12 V30 #3 (Kalthallen)4x12 with Celestion V30 speakers.
72	4x12 V30 #4 (Kalthallen)4x12 with Celestion V30 speakers.
73	4x12 G12T75 #1 (Kalthallen)4x12 with Celestion G12T75 speakers.
74	4x12 G12T75 #2 (Kalthallen)4x12 with Celestion G12T75 speakers.
75	1x8 Champier MixFender Champ with 8" speaker (Producer Pack).
76	1x8 Vibrato Champier MixFender Vibro Champ with 8" speaker (Producer Pack).
77	1x10 Prince Tone Black MixBlackface Fender Princeton with 10" speaker (Producer Pack).
78	1x10 Prince Tone Silver MixSilverface Fender Princeton with 10" speaker (Producer Pack).
79	1x12 Junior Blues MixFender Blues Junior with 12" speaker (Producer Pack).
80	1x12 Deluxe Verb MixFender Deluxe Reverb with 12" speaker (Producer Pack).
81	1x12 Deluxe Tweed MixFender Deluxe Tweed with 12" speaker (Producer Pack).

In Firmware 10 many of the factory cabs were remixed so as to sound more "in the room". The (V9) cabs have a more "studio-polished sound". Far field IRs: cabs 10, 28 and 29.

<u>AXE-FX CAB</u>	<u>DESCRIPTION</u>
82	1x12 Vibrato Lux MixFender Vibrolux with 12" speaker (Producer Pack).
83	1x12 Class-A 15w Blue MixVox AC-15 with 12" Alnico Blue (Producer Pack).
84	1x12 Division 13 MixDivided By 13 CJ 11 with 12" G12M (Producer Pack).
85	1x12 Hot Kitty MixBlack Cat Hot Cat 30R with 12" proprietary Celestion speaker (V30) (Producer Pack).
86	1x12 Hawaii MixOhau cabinet (Producer Pack).
87	1x15 Tweed Pro Mix.....Fender Pro with 15" speaker (Producer Pack).
88	1x15 Empire Mix15" Eminence speaker (Producer Pack).
89	2x10 Super Tweed MixFender Super Reverb with two 10" speakers (Producer Pack).
90	2x10 Vibrato Lux Mix.....Fender Vibrolux with two 10" speakers (Producer Pack).
91	2x12 Double Verb Mix.....Fender Twin Reverb with two 12" speakers (Producer Pack).
92	2x12 Pro Verb Mix.....Fender Pro Reverb with two 12" speakers (Producer Pack).
93	2x12 Class-A 30w Blue MixVox AC-30 with two 12" Alnico Blue speakers (Producer Pack).
94	2x12 Class-A 30w Silver MixVox AC-30 with two 12" Alnico Silver speakers (Producer Pack).
95	2x12 Supremo Mix.....Supro with two 12" speakers (Producer Pack).
96	2x12 Santiago EJ1250 Mix.....12" Eminence EJ1250 50w speaker in a Fender closed-back cabinet (Producer Pack).
97	2x12 Santiago Altec Mix.....12" Altec 417-8H speaker in a x12 half-open cabinet (Producer Pack).
98	3x10 Vibrato King Mix.....Fender Vibro-King with three 10" speakers (Producer Pack).
99	4x10 Bassguy Mix.....Fender Bassman with four 10" speakers (Producer Pack).
100	4x10 Super Verb Mix.....Fender Super Reverb with four 10" speakers (Producer Pack).
101	4x12 Basketweave Green Mix.....Marshall cabinet with four 12" G12M (greenback) speakers (Producer Pack).
102	4x12 Basketweave AX Mix.....Marshall 1960AX (angled front) with four 12" (probably greenbacks) speakers (Producer Pack).
103	4x12 Basketweave TV Mix.....Marshall 1960TV angled tall cabinet with four 12" (probably greenbacks) speakers (Producer Pack).
104	4x12 Cali Lead 80s MixMesa cabinet from the 80s with four Classic Lead 80 speakers (Producer Pack).
105	4x12 Rumble EV12L Mix.....EVM 12L speakers in a 4x12 12L/12S Dumble cabinet (Producer Pack).
106	4x12 Rumble EV12S Mix.....EVM 12S speakers in a 4x12 12L/12S Dumble cabinet (Producer Pack).
107	4x12 PVH6160 Mix.....EVH 5150 cabinet (Producer Pack).
108	4x12 Petrucci V30 Mix.....John Petrucci's Mesa 4x12 cabinet with V30s (Producer Pack). Adam Cook: "The Petrucci V30 Mix is pretty dark but that is the way he mics his cabs. It's a two mic blend and neither mic is particularly close to the center of the cab. I compared the Petrucci V30 Mix to some IR's we captured at a previous session and they are very similar."
109	1x15 SV Bass M88 Mix1x15 bass cabinet, Beyerdynamic M88 microphone (Producer Pack).
110	1x15 SV Bass Subkick Mix1x15 bass cabinet, subkick (Producer Pack).
111	4x10 SV Bass M88 Mix4x10 bass cabinet, Beyerdynamic M88 microphone (Producer Pack).
112	4x10 SV Bass Subkick Mix4x10 bass cabinet, subkick (Producer Pack).
113	4x10+Tweeter SV Bass M88 Mix4x10 bass cabinet, M88 microphone (Producer Pack).
114	1x12 Class-A 20 Dlx Mix1x12 Morgan AC20 Deluxe cabinet (Producer Pack).
115	1x12 Nuclear Tone MixSwart Atomic Space Tone cabinet, open back, 1x12 Mojotone British Vintage Series BV-25m speaker (Producer Pack).
116	1x12 Scumtone 25W MixCas Azera Tone-Tools detuned 1x12 cabinet with Scumback H55 (Producer Pack).
117	2x12 Boutique Mix.....2x12 Matchless cabinet (Producer Pack).
118	2x12 SV Legend Mix.....Carvin Legacy 2x12 cabinet, closed back (Producer Pack).
119	1x12 E12L (V9).....Firmware 9 version of cabinet 8.
120	1x12 Brit G12H30 (V9).....Firmware 9 version of cabinet 16.
121	2x12 Doubleverb D120 (V9)Firmware 9 version of cabinet 21.
122	2x12 Doubleverb C12N (V9)Firmware 9 version of cabinet 22.
123	2x15 Doubleshow (V9)Firmware 9 version of cabinet 31.
124	4x12 Basketweave G12H30 (V9)Firmware 9 version of cabinet 34.
125	4x12 1960B V30 (V9)Firmware 9 version of cabinet 41.

In Firmware 10 many of the factory cabs were remixed so as to sound more "in the room". The (V9) cabs have a more "studio-polished sound". Far field IRs: cabs 10, 28 and 29.

<u>AXE-FX CAB</u>	<u>DESCRIPTION</u>
126 4x12 Recto V30 (V9).....	Firmware 9 version of cabinet 43.
127 4x12 German V30 (V9)	Firmware 9 version of cabinet 47.
128 4x12 PVH6160 (V9).....	Firmware 9 version of cabinet 49.
129 4x12 Uber T75 (V9).....	Firmware 9 version of cabinet 50.
130 4x12 Uber V30 (V9).....	Firmware 9 version of cabinet 51.
131 4x12 Uber T75+V30 (V9).....	Firmware 9 version of cabinet 52.
132 4x12 Citrus V30 (V9).....	Firmware 9 version of cabinet 53.

In Firmware 10 many of the factory cabs were remixed so as to sound more "in the room". The (V9) cabs have a more "studio-polished sound". Far field IRs: cabs 10, 28 and 29.

<u>AXE-FX AMP</u>	<u>SPEAKER TYPE</u>	<u>AXE-FX CAB SUGGESTION</u>
1987x.....	G12M, G12H, G12L	see G12M and G12H footnotes; 35 (G12L)
5153.....	G12-EVH (G12H30)	49, 107, 128 (5150); G12Hs
59/65 Bassguy	4x10, 2x12	32, 33, 99 (4x10)
5F1 Tweed	8" speakers.....	2, 75, 76
AC-20 Dlx.....	Alnico Blue, G12H, Greenback	114
Angle Severe	V30.....	see V30 footnote
Atomica	G12H	16, 34, 57, 64, 120, 124 (G12H)
Band-Commander	2x12 (Jensen C12N)	19 (1x12); 21, 22, 91, 121, 122 (Twin)
Blankshp Leeds.....	2x10 Jensen C10Q, Alnico Blue	see Alnico footnote
Bludojai	G12-65, EVM 12L	29, 56 (G12-65), G12-65 from Mad Oak Cab Pack ; see EVM footnote
Boutique	G12M + G12H.....	26, 30, 117 (Matchless); 84, 116 (1xG12M); see G12H footnote
Brit 800/Silver.....	G12M, G12H, V30, T75	see G12M, G12H, and V30 footnotes; 39, 50, 73, 74, 129 (G12-T75); Brit 800 from Mad Oak Cab Pack
Brit JM45	G12M, G12H, G12L	see G12M and G12H footnotes; 35 (G12L)
Brit JVM	V30 + G12H.....	see V30 and G12H footnotes
Brit Pre	(preamp).....	n/a
Brit Super.....	V30.....	see V30 footnote; Brit 800 from Mad Oak Cab Pack
Buttery	G12M, G12H	see G12M and G12H footnotes; 84, 116 (1xG12M)
CA3+	(preamp).....	n/a
Cali Leggy	V30.....	118; other V30s, G12Ms
Cameron	G12H	see G12H footnote
Car Roamer	12" Eminence Elsinore	n/a
CarolAnn OD-2.....	EVM 12L, Celestion Classic Lead 80.....	see EVM footnote; 104 (Classic Lead 80)
Citrus A30, Terrier	G12H	53 (Orange); see G12H footnote
Citrus RV50	V30.....	53 (Orange); see V30 footnote
Class-A 15w/30w.....	Alnico Blue, G12M.....	see Alnico and G12M footnotes; 114
Comet.....	Greenbacks, G12H, V30.....	see G12M, G12H, and V30 footnotes
Corncob M50	60w V30	see V30 footnote
Das Metall	V30, G12K100.....	see V30 footnote; 54 (G12K100)
Deluxe Tweed.....	Jensen P12R, C12N of Alnico Blue.....	14, 81 (Deluxe); see Alnico footnote; 5, 6, 19 (1x12)
Deluxe Verb.....	1x12 (Jensen C12Q, EVM 12L, JBL D120), 2x10 (Jensen C10N, C10Q, P10R).....	3, 5, 6; see EVM footnote; 21, 22, 121, 122 (Twin); 80, 81 (Deluxe)
Dirty Shirley	G12M, G12H	see G12M and G12H footnotes
Div/13 CJ	G12M.....	84 (1x G12M)
Div/13 FT37.....	Alnico Blue + G12H30	see Alnico and G12H footnotes; if too bright, replace Alnico with G12M
Dizzy V4	V30, G12K100.....	see V30 footnote; 54 (G12K100)
Double Verb	2x12 (Jensen C12N, JBL D120, EVM-12L)	21, 22, 91, 121, 122 (Twin); see EVM footnote; 6, 19
Energyball	V30, custom V60	see V30 footnote
Euro Blue/Red	V30.....	see V30 footnote; G12Ms
Euro Uber.....	V30 + G12T75 (Uberkab)	50, 51, 52, 129, 130, 131 (Uberkab)
Fox ODS	G12-65, EVM 12L.....	29, 56 (G12-65), G12-65 from Mad Oak Cab Pack ; see EVM footnote
Friedman	G12M, G12H, V30.....	see G12M, G12H, and V30 footnotes
Fryette D60.....	Eminence P50E	?
Gibtone Scout	1x10.....	3, 4 (1x10); 84, 115, 116 (1xG12M)
Herbie.....	V30, G12K100.....	see V30 footnote; 54 (G12K100)
HiPower	4x12 Fane.....	42 (Hiwatt)
Hot Kitty.....	Bad Cat proprietary Celestion.....	85 (Bad Cat)

Alnico cabs: 7, 11, 13, 15, 20, 24, 25, 28, 55, 83, 93, 94

EVM cabs: 8, 12, 105, 106, 119

G12H cabs: 16, 34, 57, 64, 120, 124

G12M cabs: 36, 37, 38, 58, 60, 61, 101, 102, 103

V30 cabs: 41, 43, 44, 47, 48, 51, 53, 59, 62, 63, 65, 69, 70, 71, 72, 108, 125, 126, 127, 130, 132

Fractal Audio Cab Pack IRs are highlighted in red. Amps not listed have neither speaker types nor suggested cabs in the Axe-Fx II Wiki.

<u>AXE-FX AMP</u>	<u>SPEAKER TYPE</u>	<u>AXE-FX CAB SUGGESTION</u>
Jazz 120	2x12 "silver" Roland	27 (Roland)
JR Blues	C12N, P12R	79 (JR Blues)
Matchbox D-30	G12H30 + G12M	26, 30, 117 (Matchless); 84, 116 (1xG12M); see G12H footnote
Mr Z MZ-38	Alnico Blue + G12H	see Alnico and G12H footnotes; 114
Mr Z MZ-8	G12H	see G12H footnote
Nuclear-Tone	G12M	115 (1x G12M)
ODS-100	G12-65, EVM 12L	29, 56 (G12-65), G12-65 from Mad Oak Cab Pack ; see EVM footnote
Plexi	G12M, G12H, G12L	see G12M and G12H footnote; 35 (G12L)
Prince Tone	Jensen C10N	3 (1x10); 77, 78 (Princeton)
PVH 6160	Sheffield 1200	49, 107, 128 (5150); G12Ms, G12Hs
Recto	V30	see V30 footnote; 104 (Classic Lead 80)
Ruby Rocket	Alnico	see Alnico footnote; 114
Shiver	V30	see V30 footnote
Solo 88 Rhythm	(preamp)	n/a
Solo 99	(preamp)	n/a
Solo 100	12" Eminence	45, 46 (Soldano); see EVM footnote
Spawn	G12M, G12-65, V30	see G12M footnote; 29, 56 (G12-65), G12-65 from Mad Oak Cab Pack ; see V30 footnote
Suhr Badger	V30	see V30 footnote; 85 (1xV30)
Super Verb	4x10 Jensen C10R, C10Q, P10R	89, 100 (Super)
Supremo Trem	6" oval speaker, 12" or 15" Jensen	18, 95 (Supro)
SV Bass	8x10	66, 67, 68, 109, 110, 111, 112, 113 (bass cabs)
Tremolo Lux	2x10	19 (1x12); 21, 22, 91, 121, 122 (Twin); 98 (3x10)
Tube Pre	(preamp)	n/a
Two-Stone J35	G12-65	29, 56 (G12-65), G12-65 from Mad Oak Cab Pack ; see EVM footnote
TX Star Lead	Mesa C90 (a modified CL80)	see V30 and EVM footnotes; 104 (Classic Lead 80)
USA IIC+	EVM 12L	see EVM footnote; 104 (Classic Lead 80)
USA Clean 2/Pre	(preamp)	n/a
USA Sub Blues	10" Eminence Black Shadow	see V30 footnote
USA (all others)	Mesa C90 (a modified CL80)	see V30 and EVM footnotes; 104 (Classic Lead 80)
Vibrato-King	3x10	98 (Vibro-King)
Vibrato Lux	2x10 (Jensen C10Q), Oxford 1x12	82, 90 (Vibrolux); EVM 12L
Vibrato Verb	1x15 (Jensen C15N, JBL D130, Eminence), 2x10 (Jensen C10Q)	18, 31, 87, 88, 123 (1x15)
Wrecker	G12M, G12H	see G12M and G12H footnotes

Alnico cabs: 7, 11, 13, 15, 20, 24, 25, 28, 55, 83, 93, 94

EVM cabs: 8, 12, 105, 106, 119

G12H cabs: 16, 34, 57, 64, 120, 124

G12M cabs: 36, 37, 38, 58, 60, 61, 101, 102, 103

V30 cabs: 41, 43, 44, 47, 48, 51, 53, 59, 62, 63, 65, 69, 70, 71, 72, 108, 125, 126, 127, 130, 132

Fractal Audio Cab Pack IRs are highlighted in red. Amps not listed have neither speaker types nor suggested cabs in the Axe-Fx II Wiki.

CC ASSIGNMENTS

sorted by function

<u>Function</u>	<u>CC</u>	<u>Function</u>	<u>CC</u>	<u>Function</u>	<u>CC</u>
Amp 1 Bypass	37	Filter 1 Bypass	52	Phaser 1 X/Y	112
Amp 1 X/Y	100	Filter 2 Bypass	53	Phaser 2 Bypass	76
Amp 2 Bypass	38	Filter 3 Bypass	54	Phaser 2 X/Y	113
Amp 2 X/Y	101	Filter 4 Bypass	55	Pitch 1 Bypass	77
Bypass	13	Flanger 1 Bypass	56	Pitch 1 X/Y	114
Cab 1 Bypass	39	Flanger 1 X/Y	110	Pitch 2 Bypass	78
Cab 1 X/Y	102	Flanger 2 Bypass	57	Pitch 2 X/Y	115
Cab 2 Bypass	40	Flanger 2 X/Y	111	Quad Chorus 1 Bypass	79
Cab 2 X/Y	103	Formant 1 Bypass	58	Quad Chorus 2 Bypass	80
Chorus 1 Bypass	41	FX Loop Bypass	59	Resonator 1 Bypass	81
Chorus 1 X/Y	104	Gate/Expander 1 Bypass	60	Resonator 2 Bypass	82
Chorus 2 Bypass	42	Gate/Expander 2 Bypass	61	Reverb 1 Bypass	83
Chorus 2 X/Y	105	Graphic EQ 1 Bypass	62	Reverb 1 X/Y	116
Compressor 1 Bypass	43	Graphic EQ 2 Bypass	63	Reverb 2 Bypass	84
Compressor 2 Bypass	44	Graphic EQ 3 Bypass	64	Reverb 2 X/Y	117
Crossover 1 Bypass	45	Graphic EQ 4 Bypass	65	Ring Modulator Bypass	85
Crossover 2 Bypass	46	Input Volume	10	Rotary 1 Bypass	86
Delay 1 Bypass	47	Looper Bypass	33	Rotary 2 Bypass	87
Delay 1 X/Y	106	Looper Dub	31	Scene Increment	123
Delay 2 Bypass	48	Looper Half	120	Scene Decrement	124
Delay 2 X/Y	107	Looper Once	30	Scene Select	34
Drive 1 Bypass	49	Looper Play	29	Synth 1 Bypass	88
Drive 1 X/Y	108	Looper Record	28	Synth 2 Bypass	89
Drive 2 Bypass	50	Looper Rev	32	Tempo	14
Drive 2 X/Y	109	Looper Undo	121	Tone Matching	99
Enhancer Bypass	51	Megatap Delay Bypass	66	Tremolo/Panner 1 Bypass	90
External Control 1	16	Metronome	122	Tremolo/Panner 2 Bypass	91
External Control 2	17	Multiband Comp 1 Bypass	67	Tuner	15
External Control 3	18	Multiband Comp 2 Bypass	68	Vocoder Bypass	92
External Control 4	19	Multi Delay 1 Bypass	69	Volume Decrement	36
External Control 5	20	Multi Delay 2 Bypass	70	Volume Increment	35
External Control 6	21	Out 1 Volume	11	Volume/Pan 1 Bypass	93
External Control 7	22	Out 2 Volume	12	Volume/Pan 2 Bypass	94
External Control 8	23	Parametric EQ 1 Bypass	71	Volume/Pan 3 Bypass	95
External Control 9	24	Parametric EQ 2 Bypass	72	Volume/Pan 4 Bypass	96
External Control 10	25	Parametric EQ 3 Bypass	73	Wahwah 1 Bypass	97
External Control 11	26	Parametric EQ 4 Bypass	74	Wahwah 1 X/Y	118
External Control 12	27	Phaser 1 Bypass	75	Wahwah 2 Bypass	98
				Wahwah 2 X/Y	119

CC ASSIGNMENTS

sorted by CC

<u>Function</u>	<u>CC</u>	<u>Function</u>	<u>CC</u>	<u>Function</u>	<u>CC</u>
Input Volume	10	Delay 2 Bypass	48	Rotary 1 Bypass	86
Out 1 Volume	11	Drive 1 Bypass	49	Rotary 2 Bypass	87
Out 2 Volume	12	Drive 2 Bypass	50	Synth 1 Bypass	88
Bypass	13	Enhancer Bypass	51	Synth 2 Bypass	89
Tempo	14	Filter 1 Bypass	52	Tremolo/Panner 1 Bypass . .	90
Tuner	15	Filter 2 Bypass	53	Tremolo/Panner 2 Bypass . .	91
External Control 1	16	Filter 3 Bypass	54	Vocoder Bypass	92
External Control 2	17	Filter 4 Bypass	55	Volume/Pan 1 Bypass	93
External Control 3	18	Flanger 1 Bypass	56	Volume/Pan 2 Bypass	94
External Control 4	19	Flanger 2 Bypass	57	Volume/Pan 3 Bypass	95
External Control 5	20	Formant 1 Bypass	58	Volume/Pan 4 Bypass	96
External Control 6	21	FX Loop Bypass	59	Wahwah 1 Bypass	97
External Control 7	22	Gate/Expander 1 Bypass . . .	60	Wahwah 2 Bypass	98
External Control 8	23	Gate/Expander 2 Bypass . . .	61	Tone Matching	99
External Control 9	24	Graphic EQ 1 Bypass	62	Amp 1 X/Y	100
External Control 10	25	Graphic EQ 2 Bypass	63	Amp 2 X/Y	101
External Control 11	26	Graphic EQ 3 Bypass	64	Cab 1 X/Y	102
External Control 12	27	Graphic EQ 4 Bypass	65	Cab 2 X/Y	103
Looper Record	28	Megatap Delay Bypass	66	Chorus 1 X/Y	104
Looper Play	29	Multiband Comp 1 Bypass . .	67	Chorus 2 X/Y	105
Looper Once	30	Multiband Comp 2 Bypass . .	68	Delay 1 X/Y	106
Looper Dub	31	Multi Delay 1 Bypass	69	Delay 2 X/Y	107
Looper Rev	32	Multi Delay 2 Bypass	70	Drive 1 X/Y	108
Looper Bypass	33	Parametric EQ 1 Bypass	71	Drive 2 X/Y	109
Scene Select	34	Parametric EQ 2 Bypass	72	Flanger 1 X/Y	110
Volume Increment	35	Parametric EQ 3 Bypass	73	Flanger 2 X/Y	111
Volume Decrement	36	Parametric EQ 4 Bypass	74	Phaser 1 X/Y	112
Amp 1 Bypass	37	Phaser 1 Bypass	75	Phaser 2 X/Y	113
Amp 2 Bypass	38	Phaser 2 Bypass	76	Pitch 1 X/Y	114
Cab 1 Bypass	39	Pitch 1 Bypass	77	Pitch 2 X/Y	115
Cab 2 Bypass	40	Pitch 2 Bypass	78	Reverb 1 X/Y	116
Chorus 1 Bypass	41	Quad Chorus 1 Bypass	79	Reverb 2 X/Y	117
Chorus 2 Bypass	42	Quad Chorus 2 Bypass	80	Wahwah 1 X/Y	118
Compressor 1 Bypass	43	Resonator 1 Bypass	81	Wahwah 2 X/Y	119
Compressor 2 Bypass	44	Resonator 2 Bypass	82	Looper Half	120
Crossover 1 Bypass	45	Reverb 1 Bypass	83	Looper Undo	121
Crossover 2 Bypass	46	Reverb 2 Bypass	84	Metronome	122
Delay 1 Bypass	47	Ring Modulator Bypass	85	Scene Increment	123
				Scene Decrement	124

DRIVE BLOCK	DESCRIPTION
BB Pre	Xotic Pedals BB Preamp
Bender Fuzz	Classic Tonebender circuit
Bit Crusher	A black box we found lying in the trash outside Studio Harshclip
Blues OD	Marshall Bluesbreaker
Esoteric ACB	Xotic AC Boost
Esoteric RCB	Xotic RC Boost
Eternal Love	Lovepedal Eternity
Face Fuzz	Dallas Arbiter Fuzz Face
FAS LED-Drive	LED diodes have a higher voltage drop than silicon diodes
Fat Rat	Modified version of the Rat Dist; a bit fuller and smoother
FET Boost	Gentle, smooth clipping booster with tone controls
Full OD	Fulltone Fulldrive OD Pedal
Hard Fuzz	Hard-clipping, 60s-style fuzz
M-Zone Dist	Boss Metalzone, popular for extreme gain settings
Master Fuzz	Maestro Fuzztone, aka Satisfaction fuzz
Mid Boost	Custom mid-boost overdrive
Octave Dist	Tycobrahe Octavia
PI Fuzz	Big Muff Pi Fuzz
Plus Dist	MXR Distortion Plus
Rat Dist	ProCo Rat Distortion
Shred Dist	Marshall Shredmaster
Super OD	Boss Super Overdrive
T808 MOD	Captures the most popular 808 mods
T808 OD	Ibanez TS-808 Tube Screamer
Tape Dist	Simulates the clipping of an overdriven reel-to-reel tape deck.
Treble Boost	Classic Treble Booster
Tube Drv 3-Knob	Chandler/Butler Tube Driver with a 12AX7, 3-knob version
Tube Drv 4-knob	4-knob version
Zen Master	Hermida Zendrive

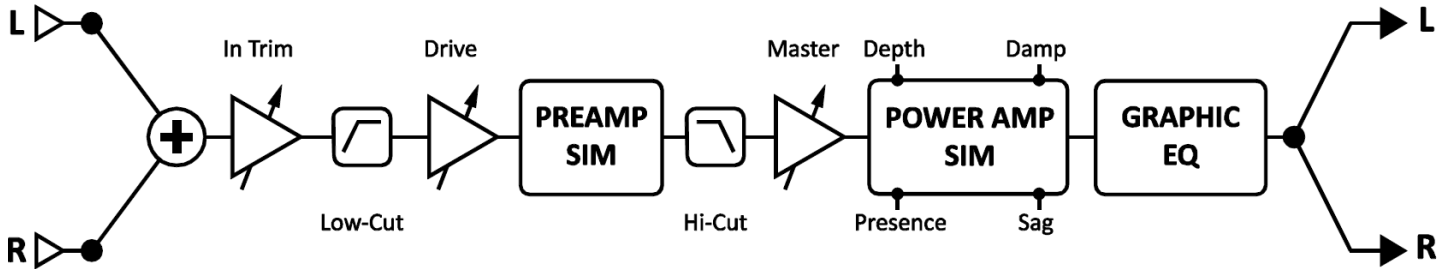

Mono Cab Sim

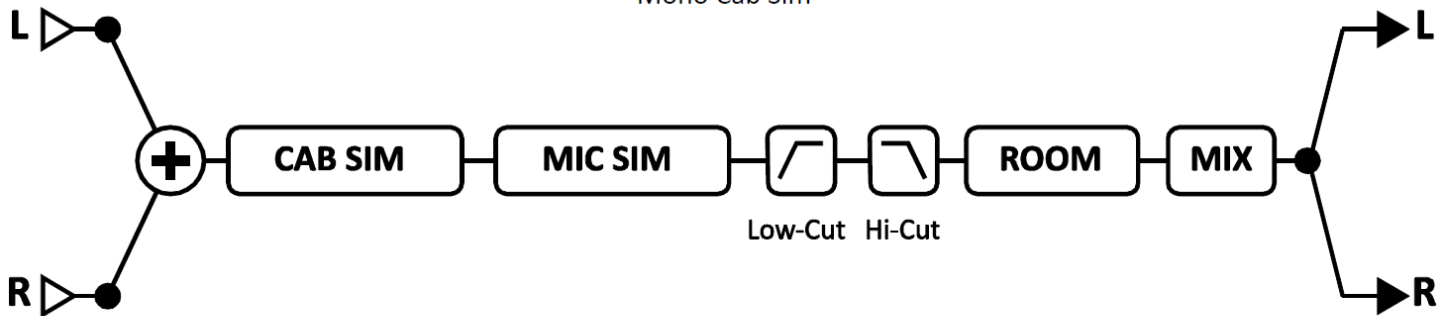

Stereo Cab Sim

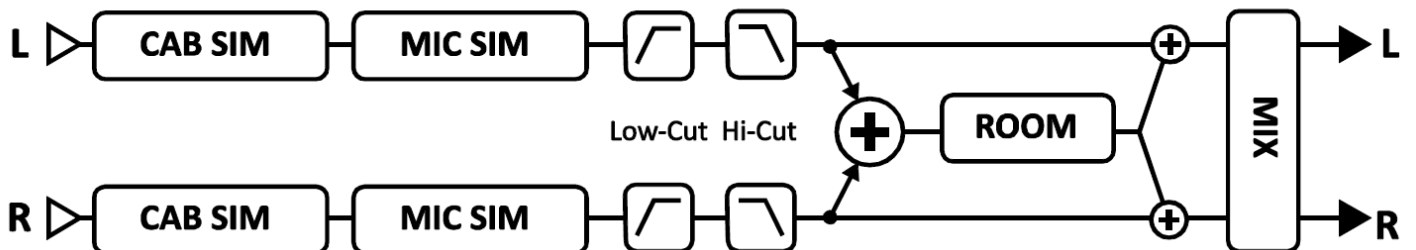

EVH 5150 III 100w AMP
recommended settings from the manual
red dots indicate Eddie's personal settings

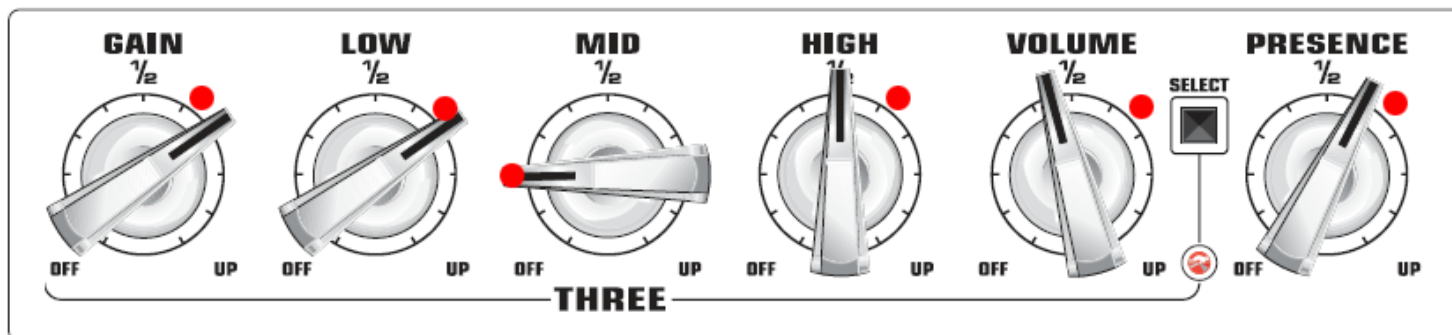
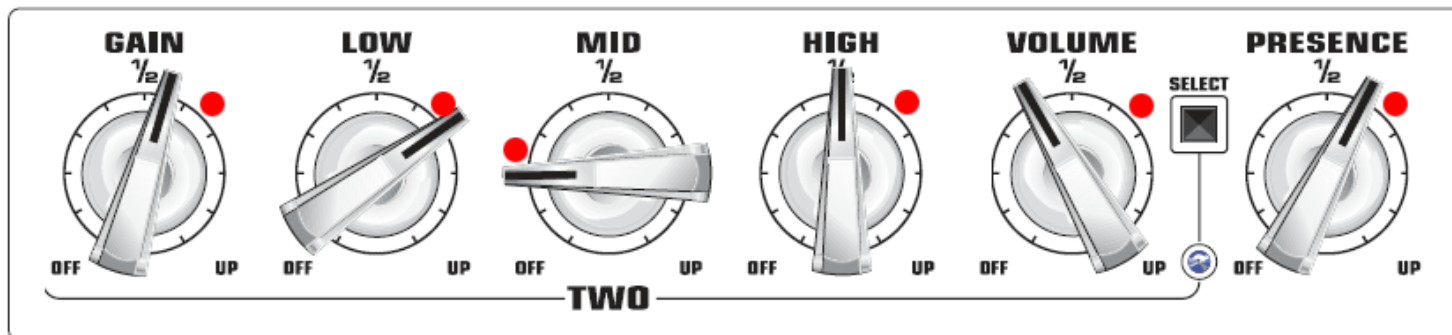
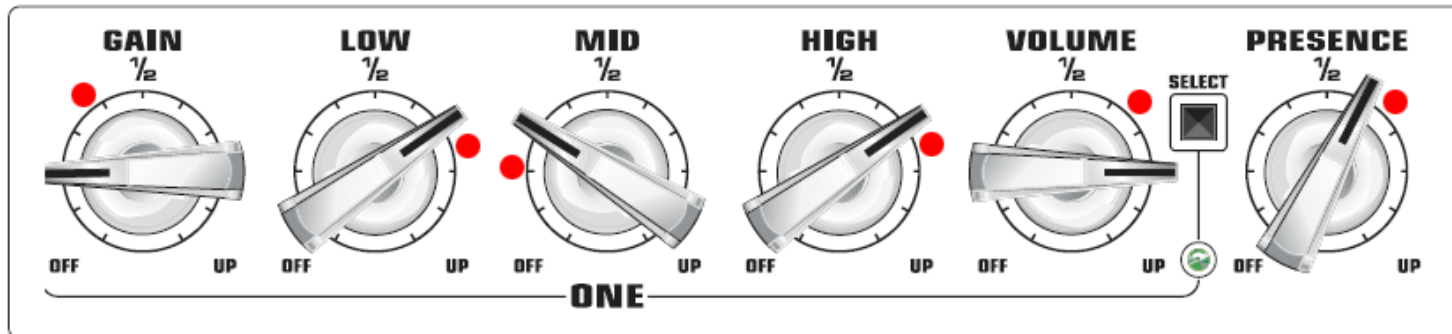

REVISION HISTORY

Red text in a parameter description indicates a new function not yet accessible in Axe-Edit.

2014-04-01 – Firmware 14.0 update, Axe-Edit 3.0.7 update.

2014-03-01 – Firmware 13.07 update, Axe-Edit 3.0.6 update.

2014-02-08 – Firmware 13.01 update, Axe-Edit 3.0.4 update.

2014-01-09 – Firmware 12.03 final.

2014-01-05 – Firmware 12.03 beta 5 update.

2013-12-23 – Firmware 12.03 update.

2013-11-09 – Axe-Edit 3.0.3 update with higher resolution screenshots more suitable for printing.

2013-11-08 – Firmware 12.0 update.

2013-10-10 – Firmware 11.04 update.

2013-09-05 – Firmware 11.02 update, Axe-Edit 3.0.1 update.

2013-09-02 – Firmware 11.01 update. Added 1987X Jump amp model and MV CAP parameter in the Amp block.

2013-08-30 – Updated the description of the COMP parameter. Added setting changes specific to jumpered amps.

2013-08-28 – Firmware 11.0 update. Axe-Edit 3.0 update. Added footnote icon to amp list noting amps with no negative feedback.

2013-07-21 – Firmware 10.12 update.

2013-07-14 – Added CC assignment list, sorted by function and CC.

2013-07-08 – Firmware 10.11 update. Added Cab Pack recommendations from the Wiki to the cab suggestion list. Added footnote symbols to the amp description list to make it easier to spot specific amp features.

2013-07-03 – Firmware 10.10 update. Added a few informative “Cliff notes”.

2013-06-29 – Updated the cab suggestion list to include the new factory cabs introduced in firmware 10. The list now accurately reflects the information on the Axe-Fx II Wiki. Also gave it a badly needed overhaul to make it more readable.

2013-06-22 – Firmware 10.09 update.