

AXE-FX II



Amp & Cab Quick Reference Guide for Axe-Edit

Amp and cab block parameters explained
Amp and cab descriptions
Amp speaker types matched with Axe-Fx cabs
Cliff's Gain Controls Guide **NEW**
Drive block descriptions
CC assignments sorted by function & CC

content compiled from the Axe-Fx II manual, Wiki and forum suggestions, corrections, etc.: send a PM to JMA at the Fractal Audio forum

firmware v18.00 ~ Axe-Edit v3.1.5 ~ rev. March 12, 2015



TOP ROW

INPUT DRIVE – Also known as Drive, Volume, Gain, etc. It is the knob closest to the input jack. In many cases it has a bright cap so the frequency response will be dependent on the knob position. As the gain increases the tone shifts from a treble and upper mid emphasis to a bass and lower mid emphasis. On jumped amps, this setting's label changes to TREBLE DRIVE.

OVERDRIVE – A second drive control for some amp models. It does not have a bright cap so it only affects the gain. Set Overdrive to 8.00 to get the identical response to pre-v10.10 firmware for models that have Overdrive. On jumped amps, this setting's label changes to NORMAL DRIVE.

INPUT DRIVE and OVERDRIVE will have a dramatic effect on the response of the amplifier and the personality of your instrument.

BASS/MID/TREB – “Passive” tone stack. Can be changed with TONESTACK TYPE.

For most tone stacks, when you set the BASS and TREB to zero, the tone stack becomes basically “flat” and the MID becomes a volume control.

PRESENCE – Decreases high frequency negative feedback in the power amp. Increased Increase it to help sound cut through a heavy mix. Decrease it to compensate for overly-bright amps. It is tightly coupled to speaker impedance (HI FREQ, HI RESONANCE.)

HI CUT – On amps with no negative feedback (NEG FDBK=0), Presence is replaced with Hi Cut, a simple high-shelf EQ at the power amp output. (Hi Cut control is non-functional in Suhr models.)

DEPTH – Boosts low frequencies from the power amp by varying the negative feedback frequency response. Amps with a fixed depth circuit have a preset value. Amps with no depth circuit default to zero (Fenders, most Marshalls, and generally most older designs). Also called “Resonance” or “Girth” on some amps. NOTE: Depth is non-functional on most of the USA amp models due to the unique topology of their feedback networks.

PRESENCE and DEPTH differ from BASS, TREBLE, and BRIGHT (Tone page) in that they are applied to the power amp as opposed to the preamp. Their effect is dependent on the amount of NEGATIVE FEEDBACK.

MASTER VOLUME – Determines the amount of power amp distortion. As it increases, the tone controls have less influence on the sound. Amp models default to a starting Master Volume setting when selected.

MASTER VOLUME defaults to 10 for non-master volume (vintage) amps. If you want more MV on non-MV amps, increase MASTER VOL TRIM.

Most MV amps achieve full volume between 2-4. Further increase compresses the bass and treble, thereby adding mids. (Bass and treble are boosted by the speaker impedance curve, so they clip earlier.) The sweet spot is that point at which the power amp starts to compress. If you want a more “open” sound, be careful not to set the MV too high. You can also lower XFORMER MATCH (a little goes a long way). You can increase LEVEL to compensate for low MV.

Cliff: The way I dial in the MV is to turn it up until the amp stops getting louder. This is the point at which the power amp is saturating heavily. Then I back it off until I get the right amount of preamp and power amp distortion. That's the sweet spot where you get the tone and the dynamics. Too little MV and it's all preamp distortion and there's not much dynamics. Too much MV and the power amp is clipping too much and it can get flubby and/or harsh.

BOTTOM ROW

INPUT TRIM – A clean, linear gain applied at the input to the amp block that adjusts the relative gain of the preamp. (This is analogous to changing the type of tube for V1 in an actual amp.) It does the same thing as the BOOST switch, the difference being that you can control how much is boosted or cut (+/-20 dB). As a rule of thumb, every 2x multiplier equals +6dB boost. In other words, Input Trim at 4.0 produces a +12dB boost. Input Trim should be set to 1.00 if you want to match the actual amp.

You can also adjust preamp gain globally with GLOBAL AMP GAIN, which affects every amp and preset. One reason you might do this is to compensate for the gain difference when switching to a hotter/quieter guitar.

On the Axe-Fx unit: GLOBAL button > CONFIG > AMP GAIN

BOOST – Toggles the input boost for an additional 12 dB of input gain. Enabling Boost sometimes works better than turning up preamp gain.

CUT – Reduces the amount of low frequencies into the amp. This can be used to achieve a tighter tone or to reduce low-end “flub”. This is similar to increasing LOW CUT (Tone page) while still retaining some low end so it doesn't get thin. Provides an easy way to cut the overpowering bass in models such as Recto, Splawn Nitro, Komet and others.

FAT – Emphasizes midrange “body” by shifting down the tone stack center frequency. Specifically, it multiplies the tone stack treble capacitor by four. Depending upon the type of tone stack, tone control settings, position, etc., the effect can be more or less noticeable. (See TONE page.)

BRIGHT SWITCH – A “treble peaker” which functions mainly to compensate for the loss of highs at low amp volume. The effect may be subtle or pronounced, depending on the amp selected, and it is also affected by the BRIGHT CAP.

DYNAMIC PRESENCE – Models the output transformer leakage inductance that results in a brightening of the tone when the power amp is pushed. Increasing this value results in a brighter response as the virtual power amp is pushed. When playing softly or at lower gains, the influence of this control is lessened. Note that this only affects the power amp modeling and is dependent on the degree of power amp overdrive. This control can also be set negative to cause the tone to darken when playing hard. This control can also be used to help “dial in” the sweet spot of an amp model. As the MV is increased an amp becomes more liquid, compressed and easier to play. However, the highs may get overly compressed causing the amp to sound too dark. The Dynamic Presence control allows you to get the desired power amp drive and liquid feeling and then bring the highs back without affecting the rest of the spectrum.

DYNAMIC DEPTH – Analogous to the Dynamic Presence control, this increases or decreases low frequencies when the virtual amp is being pushed. While real amps don't display this behavior, it is a valuable tone-shaping tool.

DYNAMIC PRESENCE/DEPTH are distortion-sensitive. The more the waveform distorts (the harder you play) the more pronounced the depth or presence boost/cut. If you play lightly (assuming you aren't using stupid amounts of gain) the controls won't seem to do much. As you play harder the effect becomes greater.

MASTER VOL TRIM – Can be used to increase (or decrease) the Master Volume for non-MV amps. If MV is 10 and you set MV Trim to 2.0 then the MV will be 20.



TOP ROW

LOW RES FREQ/Q/RESONANCE – Guitar loudspeakers have a low-frequency resonance, typically about 100 Hz. This shifts up slightly when the speaker is mounted in an enclosure and is typically lower for open back cabs. This resonance causes an increase in the power amplifier response due to the finite output impedance of the power amp. The default LF Resonance is based on the cab most likely to be used with that amp. The Low Resonance parameter can be used to increase or decrease the amount of “thunk” or “knock”.

Don't be afraid to turn LOW RESONANCE close to 10. In fact, some Celestion and Eminence speakers are equivalent to about 8-9 on LOW RESONANCE. This will increase the interaction between the power tubes and the speaker load.

HI FREQ – Sets the “corner frequency” of the speaker impedance rise due to voice-coil inductance. The speaker voice-coil presents an inductive load to the power amp at high frequencies. This inductive load, in conjunction with the output transformer capacitance, creates a high-frequency resonance. Typical guitar speakers have a corner frequency between 1 kHz and 2 kHz. Lower values give more midrange emphasis.

HI FREQ SLOPE – Allows fine adjustment of the high-frequency impedance of the virtual voice coil (which affects the slope of the impedance curve). Reducing the Slope simulates a speaker that is less inductive, increasing Slope simulates a speaker that is more inductive. Typical speakers range from 3.0 to 4.5 with the median being about 3.7. Lower values yield greater midrange while higher values are more scooped and sizzly.

HI RESONANCE – Similar to HI FREQ but this control only changes the slope of the resonance. Default value is consistent with typical “semi-inductance” of speaker voice-coil. Varying this value will change the high-frequency load presented to the power tubes.

BOTTOM ROW

XFORMER LOW/HIGH FREQ – These set the output transformer bandwidth.

XFORMER MATCH – One of the most powerful controls in the amp block. It changes the turns ratio (and therefore the primary impedance) of the output transformer, which controls how easily power tubes are driven into clipping. Decreasing causes the power tubes to clip later, the phase inverter and grid clipping become more predominant, and the speaker resonance will be more pronounced. You also reduce the power tube compression of the lows and highs. This control has more influence with higher MASTER values and low gain amps and less influence with highly compressed amps. Increase MASTER until desired amount of power amp distortion is achieved, then adjust XFormer Match for sound's character: higher = more compressed, lower = more open. The LF/HF RESONANCE parameters interact strongly with this parameter.

Use XFORMER MATCH to intentionally mismatch speaker impedance in order to get a different tone. To simulate plugging an 8-ohm speaker into a 4-ohm jack, set it to 2.0. For the other way around, set it to 0.5.

XFORMER DRIVE – Sets the amount of core saturation in the output transformer, controlling how hard the transformer is driven. Higher values simulate a smaller, more easily saturated transformer.

SPEAKER DRIVE – Simulates distortion caused by pushing a speaker too far. It interacts with the MASTER.

The SPEAKER page is not an EQ. It allows you to adjust the impedance that the virtual speaker presents to the virtual power tubes. For a guitar amp with no negative feedback, the voltage frequency response of the power amp will very closely match this since the power amp is basically a current source. For a guitar amp with negative feedback, the resulting EQ is quite different than the impedance curve since negative feedback flattens the response. If you turn NEG FDBK all the way down then the EQ will be close to the impedance curve (but still influenced by the transformer.)



TOP ROW

SUPPLY SAG – Controls power supply impedance. Higher settings simulate higher power supply impedance, causing greater tube plate voltage (B+) “droop” and giving a more compressed, spongy and looser feel. Sag interacts with the MASTER: as the power amp is pushed and draws more current from its power supply, Sag has more effect. Sag values around 2 simulate a solid-state rectifier, 4-6 a tube rectifier.

In general, the more heavily driven the power amp section is, the more effect the SUPPLY SAG has. Setting SUPPLY SAG to 0 disables the power amp and turns the MASTER into a simple level control with a 40 dB range.

CF COMP¹ – Controls the amount of preamp compression and sets the compression threshold of the cathode follower. Many models default to zero as they do not have measurable compression.

CRUNCH – Makes things more crunchy. It controls the distortion texture when you hit a note or chord.

DYNAMICS – Controls a dynamics processor that can be used to alter the dynamic response of the amp algorithms. When set below zero the amp compresses resulting in a smoother, less dynamic sound. When set greater than zero the amp expands resulting in a punchier, crunchier and more dynamic sound. Note that extreme values can have undesirable side-effects such as pumping and clipping.

OUTPUT COMP – Leveling compressor (think LA-2A) specifically tailored to reduce the output dynamic range of the Amp block. It can also be used to simulate the compression you get from a dynamic microphone and/or some mic preamps. The parameter value is the compression ratio, which equals $1 + 3 * \text{comp} / 10$. Attack and release are fixed.

COMP THRESHOLD – Sets the level at which OUTPUT COMP reduces the amplitude of the audio signal when that level is exceeded.

BIAS EXCURSION – Grid modeling parameter that controls how much the power tube grid voltage droops when the grids conduct.

EXCURSION/RECOVERY TIME – Grid modeling parameter that controls the time constants associated with BIAS EXCURSION.

BOTTOM ROW

PREAMP SAG – OFF replicates the behavior of separate preamp and power amp. ON replicates the behavior of an integrated tube head or combo amp.

B+ TIME CONSTANT – Associated with SUPPLY SAG. Controls rate of change in power tube plate supply. “B+” refers to one of the high voltage “taps” or outputs of the main power transformer. Lower values give a bouncier feel, while higher values give a tighter, more aggressive feel. The effect of lower B+ is equivalent to increasing XFORMER MATCH. A lower B+ means the plates clip sooner which is the same as increasing the turns ratio on the transformer. This is assuming that you rebias since typically lower the B+ affects the bias.

PREAMP BIAS – Controls the bias point of the last triode (cathode follower not counted) in the preamp. Depending on the bias points of the previous stages increasing or decreasing this value can alter both the harmonic content (the ratio of even/odd harmonics) and the attack characteristics. The further you move away from (roughly) zero the more even harmonics are introduced. It’s an asymmetric transfer function so you have to experiment. Typically, if the previous stage has a negative bias then increasing this value will be more noticeable and vice-versa. Use with PREAMP HARDNESS.

PREAMP HARDNESS (was TRIODE HARDNESS) – Controls how sharply the triodes enter saturation and can be used to simulate softer/harder tubes. The effect is subtle and most apparent at edge of breakup. Lower values give softer saturation and will sound softer (naturally) but have less note separation. Triode Hardness at zero gives a smoother distortion with reduced upper harmonics. Higher values give a more aggressive breakup and better note separation. Defaults to an appropriate value when an amp model is selected.

PICK ATTACK – Controls a sophisticated dynamic range processor that operates on leading edge transients. Negative values reduce pick attack while positive values enhance it.

CATHODE TIME¹ – Sets the attack time of the compressor.

CATHODE RATIO¹ – Sets the maximum amount of compression, with lower values giving more compression.

The cathode “squish” modeling algorithm improves the feel of cathode-biased power amp models (Class-A, Mr Z, etc.) It has two adjustable parameters:

CATHODE SQUISH – Sets the amount of bias shift due to cathode voltage rise. (Zero defeats the cathode squish modeling.)

SQUISH TIME – Sets the time constant of the cathode network.

Ghost notes are the result of a 120Hz signal plus harmonics getting past the power supply filtering. High SUPPLY SAG along with low B+ TIME CONSTANT can cause “ghost notes” when POWER SUPPLY TYPE is AC (as in a real amp). Lower B+ Time Constant values will make the amp feel “faster” but too low can cause ghost notes.

To hear what ghosts notes sound like, try the following: take an amp like Plexi 100W, turn the SAG up and the B+ TIME CONSTANT down, then play single notes around the 5th fret on the G string. You should hear a tone unrelated to the pitched note.

¹ cathode follower algorithm parameter



TOP ROW

PRESENCE SHIFT – Only available on Mesa Boogie Mark IV's with a "Pull Shift" on the Presence knob (USA LEAD and USA RHYTHM). When engaged, it normalizes the amount of high frequencies produced in the power section. PRESENCE will be more effective and will act on a higher frequency range. Note that it may result in volume reduction since the negative feedback is increased which lowers the loop gain.

PRESENCE FREQ – Alters the center frequency of the amp's PRESENCE control.

DEPTH FREQ – Alters the center frequency of the amp's DEPTH control.

POWER TUBE TYPE – Selects a specific power tube type and sets DYNAMIC DAMPING. This doesn't change the sound in the same way actually changing tubes would because it only changes the distortion curves, not the transconductance. In real amps, an EL34 has more than twice the transconductance of a 6L6. This means the plate current will be twice as great for a given grid voltage. This makes EL34s sound "more midrangey" and 6L6s sound "tighter" or "fuller".

DYNAMIC DAMPING – Adjusts the plate characteristics. Defaults to the appropriate value when an amp model or power tube type is selected.

POWER TUBE BIAS – Sets the quiescent operating current of the virtual power tubes. Increase it to reduce crossover distortion and vice-versa. Lower values approach pure Class-B operation. Higher values approach pure Class-A.

Increase POWER TUBE BIAS to thicken clean tones; reduce it to add aggression to high-gain sounds. A value of 0.5 or so will run the virtual tubes at around 75% of full power and clean tones will sound warmer but you will lose that sizzle on high-gain tones.

MV LOCATION – Location of the Master Volume.

PRE-PI – Before the phaser inverter (most amps).

POST-PI – After the phase inverter (AC types). This causes the PI to clip before the grids (if the MV is less than full). This creates a very aggressive and open sound.

PRE-TRIODE – Amp types based on Hiwatt models.

POST-PI MV turns a lot of mid-gain amps into ripping monsters. The only caveat is that, like a real amp, the more you turn the MV down the less effective Presence and Depth become (since the loop gain is reduced).

BOTTOM ROW

NEGATIVE FEEDBACK – Controls the amount of negative feedback in the power amp. The feedback decreases output impedance, causing the amp to react less to the speakers ("damping"). Higher values give a brighter, tighter, punchier sound but can be harsh at very high MASTER levels. Lower values give a smoother, loose and gritty sound and feel.

Setting NEGATIVE FEEDBACK to 0 disables negative feedback and replaces the PRESENCE control with HI CUT. DEPTH is also disabled since it only affects negative feedback.

TRIODE1/2 PLATE FREQ – Sets the cutoff frequency of the plate impedance for the next-to-last (triode 1) and last (triode 2) triode in the chain, which allows you to control the buzziness that sometimes occurs with higher gain settings. The capacitor across the triode's plate resistor is used to smooth the response and reduce noise. You can adjust the amount of capacitance, and the resulting frequency. Lowering the frequencies dials out sharpness and "fizz", making the tone smoother.

If you are right on the edge of breakup the triode hardness is very powerful as it controls the harmonic series. Higher values will cause the overtone series to have a less steep decay and will increase perceived "sparkle". Together with PREAMP BIAS you can control how chimey and "round" the tone is.

PWR AMP BIAS – Controls the amount of power tube mismatch by adjusting the offset voltage of the virtual power amp. A value of zero produces nearly symmetrical clipping which will produce very little even harmonics. Higher values will produce increasingly asymmetrical clipping which increases the amount of even harmonics. Small amounts of even harmonics can make the power amp distortion sound "warmer" and more bell-like while higher amounts will give a "fuzzier" tone.

PWR AMP HARDNESS – Controls the hardness of the virtual power tube grid clipping.



TOP ROW

LOW CUT FREQ – Reduces the amount of low frequency (10-1000Hz) before the preamp input. Use this to tighten up a tubby bass end. Somewhere between 10-150Hz is generally where it will sound best for standard guitar tones. Also see CUT (Basic page).

In the design of some amps the LOW CUT FREQ is dependent upon the DRIVE setting. In these cases the LOW CUT FREQ parameter defaults to 10 Hz and the actual low cut filtering is calculated as part of the DRIVE function.

HIGH CUT FREQ – Reduces the amount of high frequency (2k-20kHz) after the preamp output. Lower the value to make your top end sound smooth and silky, raise it to make it brilliant and defined.

BRIGHT – High treble control shelving filter between the preamp and power amp. It may be used to darken or brighten the output of the preamp. It accurately replicates the “Presence” control found in the Mesa Triaxis preamp when set to negative values. (In the Triaxis, it is actually a high frequency cut shelving filter.) Note: this is not to be confused with the BRIGHT switch which engages/disengages a capacitor across the drive pot.

DEFINITION – A basic “tilt EQ” located at the amp input. It changes the fundamental character of the amp from vintage to modern or vice-versa. Positive values increase the amount of upper overtone saturation, negative values reinforce lower harmonics.

BRIGHT CAP – Sets the value of the capacitor which determines the sonic effect of the BRIGHT switch. Increase to make the preamp brighter and vice-versa.

MV CAP – Sets the value of the bright cap across the Master Volume pot. Setting it to 1.0 pF disables it.

BOTTOM ROW

TONESTACK TYPE

ACTIVE – Gives each tone control ± 12 dB boost/cut making them more sensitive; they also will not interact with each other.

DEFAULT – Matches the tone stack with the selected amp type.

[AMP] – Replaces the default tone stack with one from another amp.

The tone stack is one of the main things that gives an amp its particular voice, as it shapes the frequency response pretty drastically.

For a flat tone stack, set the TONESTACK TYPE to NEUTRAL with B/M/T at noon. This allows the flexibility of being able to boost or cut bass and treble.

TONE FREQ – Sets the center frequency of the tone controls. This control works whether you are using PASSIVE, ACTIVE, or substitute tone stacks.

tone location

PRE – Places the tone stack at the input to the preamp.

POST – Places it between the preamp and power amp.

MID – Places it between the last two triode stages.

END – Places it after the power amp (which is impossible with a real amp).

The farther upstream you position the stack, the thinner the sound.

MID will sound chunkiest, with END being rather dark.

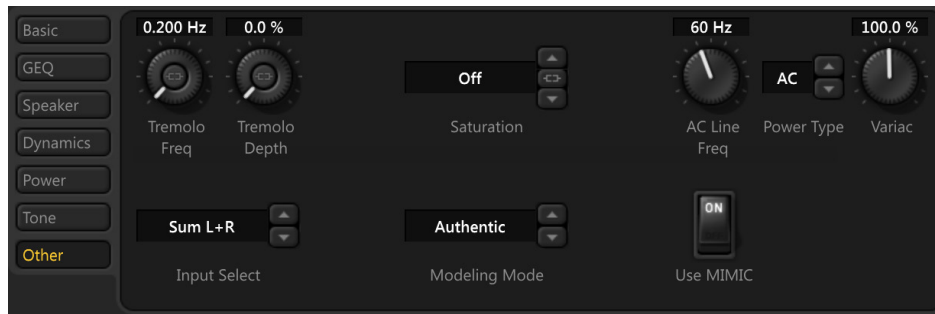

TOP ROW

TREMOLO FREQ/DEPTH (bias tremolo) – Works by varying the bias of the virtual power tubes, resulting in a particularly “organic” sound. Most importantly, the tremolo is “self-ducking” and decreases at higher signal amplitudes. On some amps high values of bias trem depth can result in excessive crossover distortion. On others, the tremolo can vary greatly between loud and soft playing.

SATURATION – Switches in a zener diode clipping stage between the preamp and the tone stack (the “Arrendondo Mod”) for more aggressive distortion character which also adds compression and cuts volume.

AUTH – replicates authentic saturation circuit behavior and lowers the volume out of the virtual preamp.

IDEAL – replicates the idealized behavior from firmware v14.xx and earlier.

SATURATION changes the distortion character. To preserve the distortion character and tone use **BOOST** or **INPUT TRIM** instead.

AC LINE FREQ – Selects the line frequency.

POWER TYPE – When set to AC, models AC rectification and resulting supply ripple. High **SUPPLY SAG** along with low **B+ TIME CONSTANT** can cause “ghost notes” when the supply type is AC (as in a real amp). Lower **B+ Time Constant** values will make the amp feel “faster” but too low can cause ghost notes.

VARIAC – AC voltage control that sets the relative AC line voltage into the amp simulation implementing a virtual “Variac”. Note that normally the volume would vary with the Variac setting in a real amp but the simulation compensates for the volume change by applying the inverse. This mitigates having to manually compensate using the Output Level.

BOTTOM ROW

INPUT SELECT – The Amp block processes audio in mono. This control determines how incoming stereo signals will be processed.

MODELING MODE – Varies between “realistic” and “idealized” preamp and power amp modeling.

AUTHENTIC – Replicates a tube amplifier with the utmost accuracy.

SMOOTH – Sets Triode Hardness to the minimum value essentially creating an ideal preamp and turns off grid conduction modeling in the power amp. This removes most of the “nasty” distortion that tube amps create.

IDEAL – Removes most of the “warts” from the modeling which includes grid conduction, output transformer distortion, bias shifting, and AC power supply modeling. Supply sag, screen voltage effects, and crossover distortion are still modeled.

IDEAL/SMOOTH – Same as Smooth, except it also sets Triode Hardness to its lowest value. This is in essence an ideal preamp plus an ideal power amp.

ADDITIONAL NOTES ON MODELING MODE

The audibility of these settings is dependent upon the particular amp model and various parameters. The use of these modes in conjunction with other parameters can yield idealized tones not achievable with real tube amps.

AUTHENTIC duplicates the previous behavior of the deprecated **Grid Modeling*** parameter.

When **IDEAL** is chosen, the global **Modeling Version** parameter is irrelevant.

* **Grid modeling** replicates grid conduction in the preamp and power amp stages, which adds “real world” high frequency “fizz” or “grit”. Grid modeling parameters include **BIAS EXCURSION** and **EXCURSION/RECOVERY TIME**.

USE MIMIC – Identifies deviations in the response of the simulated amplifier to the actual amplifier and generates corrective data bringing a level of accuracy that has been heretofore unachievable.

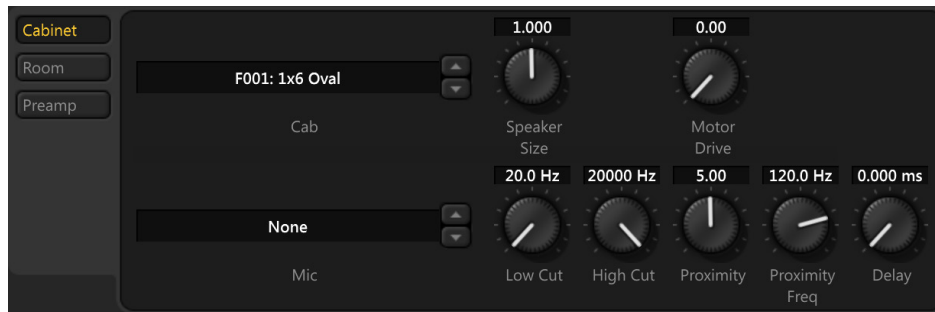

TOP ROW

CAB – Loads a cabinet impulse response (IR). The older FAS and RW cabs were recorded with neutral mics. OH, Kalthallen, and the Mix/Producer Pack series have matching mics included in the IR.

SPEAKER SIZE (NORMAL/HI RES ONLY) – “Scales” the IR to simulate shrinking or enlarging of the speaker. This effect can be used to shift where the tone sits in a mix, or to create dramatic effects. Subtle settings (0.9-1.1) will sound most natural. UltraRes IRs do not support size warping, therefore, this parameter is disabled for UltraRes cabinets.

MOTOR DRIVE – Models the effect of high power levels on speaker tone. Simulates the impedance and distortion effects that occur when the speaker is pushed hard. Be aware this setting adds a little compression as you increase it. This parameter appears on the ROOM page for stereo cabs.

MIC TYPES

57 DYN – Shure SM57
 58 DYN – Shure SM58
 421 DYN – Sennheiser MD 421 II
 87A COND – Shure Beta 87A
 U87 COND – Neumann U87
 E609 DYN – Sennheiser e609 Silver
 RE16 DYN – Electro-Voice RE16
 R121 COND – Royer Labs R-121
 D112 DYN – AKG D112
 67 COND – Neumann U67
 NULL – allows PROXIMITY without a mic

BOTTOM ROW

MIC – Don’t feel that you have to add a mic unless you *want* to add EQ, which is basically what you would be doing.

LOW/HIGH CUT – Adjusts the cutoff point of first order low/high pass filters. Increase the Low Cut if the sound is too “bassy” or “boomy.” Decrease the High Cut for a darker cab tone. Common settings are 80-150 Hz for high pass, and 5-7 kHz for low pass.

PROXIMITY – Causes an increase in bass or low frequency response as proximity is increased (closer to speaker). Disabled when MIC is set to None.

PROXIMITY FREQ – This allows tuning the frequency range over which the proximity effect occurs. This parameter appears on the ROOM page for stereo cabs.

DELAY – Delays the signal up to 1 second. With cab in stereo mode or with two cab blocks in parallel, delaying one cab relative to the other can achieve interesting comb filter effects. A common practice in studio recording is to use multiple mics on a speaker at different distances to intentionally introduce it. The effect is most pronounced when the cabs are summed to mono.



TOP ROW

ROOM LEVEL/SIZE – Determines the level and size of room reverb that is built into the cab block. Increase to add room ambience to the sound.

MIC SPACING – Increases delay times inside the room reverb by simulating the distance of the room microphone from the sound source.

AIR - Mixes some of the signal going into the Cab block with the signal leaving the Cab block.

AIR FREQUENCY – Sets the cutoff frequency of the mixed signal. Increase to maximum value for a straight mix.

BOTTOM ROW

INPUT SELECT – Can be used to run two Cabinet blocks in parallel for stereo processing by setting one to Left and the other to Right.

Scott Peterson Tip – When using headphones (I use Audio Technica ATH-M50) use the Room controls in the cab block to simulate early reflections. It’s a HUGE aspect usually missed with headphones.

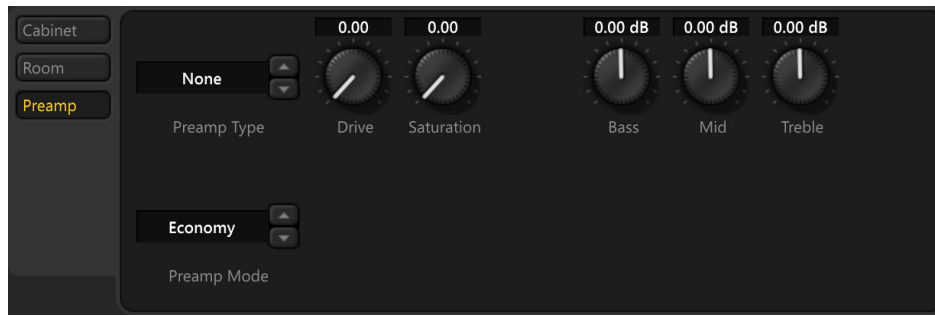

TOP ROW

PREAMP TYPE – Preamp simulation menu selections recreate the sound of overdriven channel strips, preamps, tapes, etc.

DRIVE – Controls the gain of the simulation.

SATURATION – Controls the ratio of even/odd harmonics. Turning the knob clockwise increases even harmonics.

BOTTOM ROW

PREAMP MODE – Selects either Economy or High Quality modes. In High Quality mode oversampling is employed to prevent aliasing but this results in higher CPU usage.



EFFECT TYPE

HI-/ULTRA-RES – Mono processing of Hi Res IRs (2048 samples, 43ms), or UltraRes IRs (up to 8000 samples, 167ms).

NORMAL RES – Mono processing of normal resolution IRs (1024 samples, 21ms).

STEREO ULTRARES – Stereo processing of UltraRes IRs.

STEREO – Stereo processing at normal resolution (2 × 1024).

To calculate length: 1 millisecond = 48 samples.

LINK (CABINET Page - STEREO ONLY) – Sets the left channel parameters as master controls, which set identical values for left and right. You can still set right channel values independently.

UltraRes enhances the spectral resolution of an IR without adding CPU burden.

<u>AXE-FX AMP</u>	<u>BASED ON</u>	<u>DESCRIPTION</u>
1959SLP Jump	Marshall 1959SLP	reissue of a late 60's 100w Marshall Super Lead model 1959. See PLEXI 100W for the original. Emulates "jumpering the inputs" on a 4-hole amp.
1959SLP Normal	Marshall 1959SLP	Normal channel.
1959SLP Treble	Marshall 1959SLP	Treble channel.
1987X Jump	Marshall 1987x Vintage Series	Reissue of the 50w JMP Lead 1987. Features an "essential" mod to the tonestack of this Plexi. Emulates "jumpering the inputs" on a 4-hole amp.
1987X Normal	Marshall 1987x Vintage Series	Normal channel.
1987X Treble	Marshall 1987x Vintage Series	Treble channel.
5153 Blue	EVH 5150 III (Blue)	Blue (rhythm) channel of the 100w 6L6 model, made in collaboration with Fender. Recommended settings.
5153 Green	EVH 5150 III (Green)	Green (clean) channel.
5153 Red	EVH 5150 III (Red)	Red (high gain/lead) channel.
59 Bassguy	Fender Bassman	1959, Tweed era, 5F6-A circuit. Low-to-medium gain amp designed for bass but widely adopted by guitarists.
5F1 Tweed	Fender Champ	5F1 circuit ('58-'64), single-ended, Class A, 5w. This particular amp exhibits a unique breakup characteristic due to its single-ended design and simple circuit.
65 Bassguy Nrm1	Fender Bassman	1965 Blackface version, AB165 circuit which is very crunchy and bright and does not sound like a typical Fender.
65 Bassguy Bass	Fender Bassman	Bass channel.
AC-20 Dlx 12Ax7	Morgan AC20 Deluxe	Treble channel with the EF86/12AX7 preamp tube switch in the 12AX7 position, EL84 tubes. Normal/Brilliant switch = Brilliant.
AC-20 Dlx Bass	Morgan AC20 Deluxe	Bass channel with the EF86/12AX7 preamp tube switch in the EF86 position, EL84 tubes. Normal/Brilliant switch = Normal. Bright OFF + treble booster = Brian May, Bright ON = U2.
AC-20 Dlx Treb	Morgan AC20 Deluxe	Treble channel with the EF86/12AX7 preamp tube switch in the EF86 position, EL84 tubes. Normal/Brilliant switch = Brilliant.
Angle Severe 1	ENGL Savage 120	Rough channel. Contour = OFF: boosts lower midrange around 500 Hz (warm tone.)
Angle Severe 2	ENGL Savage 120	Contour ON: boosts from 1200 Hz and cuts lower midrange (more transparency.)
Atomica High	Cameron Atomica	A "brown sound" 100w amp, high gain channel.
Atomica Low	Cameron Atomica	Low gain channel.
Band-Commander	Fender Bandmaster	1968 Silverface Fender Bandmaster with the AB763 circuit.
Big Hair	80's metal	Mids without mud. Revive the 80s metal scene. (Spandex not included.)
Blanknshp Leeds	Blankenship Leeds 21	EL84 tubes. Boutique version of an 18w Marshall with a big sound at low power. Mercury Magnetics transformers.
Bludojai Clean	Bludotone Ojai (Clean)	Reported to be an exact clone of Robben Ford's Tan Dumble. Clean mode modeled with preamp boost (PAB) engaged as the owner prefers this. To disengage PAB change the tonestack type to Skyline.
Bludojai Lead	Bludotone Ojai (Lead)	Lead mode.
Bogfish Brown	Bogner Fish preamp	Blue 4-channel tube preamp. Brown = fat high gain.
Bogfish Strato	Bogner Fish preamp	Strato = tight high gain.
Boutique 1	Matchless Chieftain	Medium-gain amp, thick, yet crisp, with a fair amount of power amp breakup. Based on a Vox circuit.
Boutique 2	Matchless Chieftain	Added Boost for more gain and high-frequency emphasis.
Brit 800	Marshall JCM800	Model 2204. Bring the Master up for true 80's tone. To soften the attack, lower Triode Freq and increase Neg Fdbk.
Brit 800 Mod	modded Marshall JCM800	Removed the treble peaker, making the amp "heavier" and "less strident".
Brit AFS100 1	Marshall AFD100SCE	#34/AFD switch set to #34 mode (LED = off), the equivalent of a JCM800 (2203). 6550 tubes.
Brit AFS100 2	Marshall AFD100SCE	#34/AFD switch set to AFD mode (LED = on), adds extra gain stage. 6550 tubes.
Brit Brown	Van Halen's Marshall	Faithful recreation of the legendary "Brown Sound" - The modded "#1" Marshall.
Brit JM45	Marshall JTM45 (Ch 1)	Made famous by Clapton and others; a modified Bassman design. Try with a Tonebender or Treble Booster.
Brit JM45 Jump	Marshall JTM45 (Ch 1)	Emulates "jumpering the inputs" on a 4-hole amp.

Red amps are non-MV (no Master Volume on the real amp). The MASTER VOLUME is set to 10 by default.

⊕ Includes the additional OVERDRIVE control.

⊗ The actual amp has a control labeled "Tone" which corresponds to TREB on the Axe-Fx. For a more realistic simulation, leave BASS and MID at noon.

⊗ Amps with NEGATIVE FEEDBACK set to zero. PRESENCE is replaced with HI CUT. DEPTH is also disabled since it only affects negative feedback.

<u>AXE-FX AMP</u>	<u>BASED ON</u>	<u>DESCRIPTION</u>
Brit JVM OD1 Gn	Marshall JVM410 (OD1, Green)	OD1 channel, Green mode, hot-rodded.
Brit JVM OD1 Or	Marshall JVM410 (OD1, Orange)	OD1 channel, Orange mode, extra gain. For Red mode, enable Boost or increase the Input Trim parameter.
Brit JVM OD2 Gn	Marshall JVM410 (OD2, Green)	OD2 channel, Green mode, lower mids than OD1.
Brit JVM OD2 Or	Marshall JVM410 (OD2, Orange)	OD2 channel, Orange mode, more gain and lower mids than OD1. See above for Red mode.
Brit Pre	Marshall JMP-1	Rack-mount preamplifier version of the Brit 800. OD2 channel. Crunchy "ZZ" tone.
Brit Silver	Marshall Silver Jubilee	100w Marshall Silver Jubilee (2555), commemorative "25/50" model. Slightly darker and higher gain than JCM800.
Brit Super	Marshall AFD100	100w dual-mode head with 6550 tubes, believed to be a modified 1959 Tremolo. Used by Slash on "Appetite for Destruction". Based on a schematic. See Brit AFS100 1 & 2 for updated models based on the actual amp.
Buttery	Budda Twinmaster	Based loosely on a late 90's specimen. Relies mostly on power amp distortion.
CA OD-2	Carol-Ann OD-2	50W, EL34 or 6L6 tubes. Overdrive channel. Model fine-tuned by the highly respected Alan Phillips.
CA Triptik Cln	Carol-Ann Triptik (Clean)	50w, EL34. Clean channel.
CA Triptik Clsc	Carol-Ann Triptik (Classic)	Classic channel: A little less gain and low end. Produces 70's and 80's British rock tones with a very wide and complex sound stage with no buzz or brittle high frequencies.
CA Triptik Mdrn	Carol-Ann Triptik (Modern)	Modern channel: More gain and low end for those more modern heavy rhythm, dropped tunings. Also makes for a superb liquid lead channel with incredible sustain and harmonic bloom.
CA Tucana 3	Carol-Ann Tucana 3	Lead channel of this 3-channel amp, with Bias monitoring system, KT88 75W tubes. This is a great lead amp which works well with many speaker/cab combinations. "One of the best amps in the world," says Cliff.
CA3+ Clean	CAE 3+ SE preamp (Ch 1)	Custom Audio Electronics preamp. The Clean channel is based on a Blackface Fender Twin Reverb preamp.
CA3+ Lead	CAE 3+ SE preamp (Ch 3)	Channel 3 (Lead). The CAE 3+ SE is basically an OD-100.
CA3+ Rhy	CAE 3+ SE preamp (Ch 2)	Channel 2 (Rhythm).
Cali Leggy	Carvin Legacy VL100	Legacy 1, 100w, EL34. Uses a "James" tone stack which is more like hi-fi tone controls. Based on Steve Vai's original signature Legacy amplifier. To get a Steve Vai tone, keep Treble low, Bass high and not too much Gain.
Cameron Ch 1	Cameron CCV100 (Ch 1)	An amp its creator Mark Cameron calls "one pissed off amp."
Cameron Ch 2	Cameron CCV100 (Ch 2)	Higher gain tone. On Channel 2, Saturation is engaged by default, no Presence (set it to 0).
Car Roamer	Carr Rambler	Basically a Deluxe Reverb preamp with cathode bias 6L6 power amp and no negative feedback. Fender-meets-Vox. On the actual amp, a toggle switch engages either the 28w pentode or 14w triode.
Citrus A30 Cln	Orange AD30HTC (Clean)	30w tube head, Clean channel.
Citrus A30 Drty	Orange AD30HTC (Dirty)	30w tube head, Dirty channel.
Citrus Bass 200	Orange AD200B	200w valve bass head, 6550 tubes.
Citrus RV50	Orange Rockerverb	"Dirty" channel of the 50w head known for warmth and rich harmonics.
Citrus Terrier	Orange Tiny Terror	7w or 15w, EL84 tubes. The actual amp has no tone stack (neutral in Axe-Fx) and a single Hi-Cut tone control.
Class-A 15w TB	Vox AC-15 Top Boost	15w, EL84 tubes. The heart of this amp's tone comes from its power section and no negative feedback.
Class-A 30w	Vox AC-30	30w, EL84 tubes. Combo that dominated the British Invasion. Gritty character, warm tone, great feel. For authentic tone, leave the tone controls at noon and use Hi-Cut to cut treble.
Class-A 30w Hot	Vox AC-30 HW	30w, EL84 tubes. Hot/Cool switch in the Hot position.
Class-A 30w TB	Vox AC-30 Top Boost	30w, EL84 tubes. Created in response to demand for "more treble". Great highs and slightly reduced bass.
Comet 60	Komet 60	EL34 tubes.
Comet Concourse	Komet Concorde	EL34 tubes. Similar to Trainwreck amp. Response switch = "Fast". To replicate "Slow" reduce INPUT TRIM to 0.25"
Concert 6G12	Fender Concert 6G12	1959-1963 4x10 brownface, 40w.
Corncob M50	Cornford MK50 II	Boutique British amp. Plexi-meets-modern tone with big cojones.
Das Metall	Diezel VH4 (Ch 4)	EL34 or 6L6 tubes. High-gain, boutique amp famous for its powerful, heavy, aggressive sound. See <i>Dizzy V4 4</i> .
Deluxe Tweed	Fender Tweed Deluxe	Fender Deluxe (5E3) from the 50's, 15w. The earliest and most popular of the so-called Tweed amplifiers. "60's hippie rock in a bottle," says Cliff.

Red amps are non-MV (no Master Volume on the real amp). The MASTER VOLUME is set to 10 by default.

⚡ Includes the additional OVERDRIVE control.

🎛️ The actual amp has a control labeled "Tone" which corresponds to TREB on the Axe-Fx. For a more realistic simulation, leave BASS and MID at noon.

🔇 Amps with NEGATIVE FEEDBACK set to zero. PRESENCE is replaced with HI CUT. DEPTH is also disabled since it only affects negative feedback.

<u>AXE-FX AMP</u>	<u>BASED ON</u>	<u>DESCRIPTION</u>
Deluxe Verb.....	Fender Deluxe Reverb.....	1965 Blackface, 22w, AB763 circuit. Great, chimey tone with nice power amp breakup.
Dirty Shirley	Friedman Dirty Shirley.....	40w, 6L6. Designed to be an ultra-fat, sweet-sounding, classic rock amp. Based on a JTM45.
Div/13 CJ ☞.....	Divided by 13 CJ 11	11w, bassy amp, works best with single coils. High-performing "Tweed" meets "EL34" meets "Master Vol" 1x12.
Div/13 FT37 Hi ☞.....	Divided by 13 FTR 37	Divided by 13 FTR 37, 37w, Class-AB, two channels, 6V6 tubes. Gain Boost ON.
Div/13 FT37 Lo ☞.....	Divided by 13 FTR 37	Gain Boost OFF.
Dizzy V4 Blue 2.....	Diezel VH4 (Ch 2).....	High-gain boutique amp with heavy, aggressive sound. 6550, EL34 or 6L6. Channel 2, "gritty funk, dynamic clean."
Dizzy V4 Blue 3.....	Diezel VH4 (Ch 3).....	Channel 3, the favorite channel for most users, with higher gain but still big dynamic range.
Dizzy V4 Blue 4.....	Diezel VH4 (Ch 4).....	Channel 4, newer version of <i>Das Metall</i> . A monster of gain which still has great definition and authority.
Dizzy V4 Slvr 2.....	Diezel VH4 (Ch 2).....	Silver-faced version of the Diezel VH4.
Dizzy V4 Slvr 3.....	Diezel VH4 (Ch 3).....	Silver-faced version of the Diezel VH4.
Dizzy V4 Slvr 4.....	Diezel VH4 (Ch 4).....	Silver-faced version of the Diezel VH4.
Double Verb	Fender Twin Reverb	100w, 1966 Blackface, AB763 circuit. Known for amazing clean sounds and nice breakup.
Energyball	ENGL Powerball	100w Lead channel, 6L6 tubes. Very high-gain German model. Lots of bass. Great for aggressive, drop-tuned riffs.
Euro Blue	Bogner Ecstasy (Blue).....	20th Anniv. model. Dark amp, turn up Presence or engage Bright. Blue channel, Structure switch = 'V' (Vintage).
Euro Blue Mdrn	Bogner Ecstasy (Blue).....	Blue channel, Structure switch = 'M' (Modern).
Euro Red.....	Bogner Ecstasy (Red)	Red channel, Structure switch = 'V' (Vintage).
Euro Red Mdrn.....	Bogner Ecstasy (Red)	Red channel, Structure switch = 'M' (Modern).
Euro Uber.....	Bogner Überschall	120w, EL34. High Gain channel. Heavy grinding lows and insane gain. Sweep Presence for a wide variety of tones.
FAS 6160.....	Peavey EVH 5150.....	Alternative version of the PVH 6160, more open and less fizzy than the original amp. Also, a virtual choke has replaced the resistor found on the original's power supply filter. This results in a bouncier feel.
FAS Bass	n/a	Custom Fractal bass model. This amp uses an active tone stack so the Fat switch will have no effect.
FAS Brootalz	ENGL Savage 120 / SLO 100.....	ENGL Savage model with the input stage (and possibly power amp) from an SLO100.
FAS Brown	Van Halen's Marshall.....	Original BROWN model from the Axe-Fx Standard/Ultra.
FAS Class-A ☞.....	Carr Rambler.....	A "Blackface" preamp into a cathode-biased 6L6 power amp with no negative feedback. This was a happy accident when originally modeling the Carr Rambler in the beta version of firmware v12.03.
FAS Crunch	ultimate British amp.....	More dynamic and open than a Plexi, but with more gain.
FAS Lead 1	Mesa Boogie TriAxis (presumed) ..	Neutral high-gain lead with a tight midrange.
FAS Lead 2	Mesa Boogie TriAxis (presumed) ..	Hot-rodged British lead sound with a tonestack by Bob Bradshaw (Custom Audio Electronics).
FAS Modern.....	high gain rhythm + lead hybrid ..	High-gain hybrid. Equally well-suited to modern rhythm or lead work. Loosely based on a Recto with tighter bass.
FAS Modern II.....	high gain rhythm + lead hybrid ..	Tighter version of the popular FAS Modern model with a 5150-style bass boost in the tone stack.
FAS Modern III	high gain rhythm + lead hybrid ..	Similar to a Recto, but with tighter bass and a cathode-based power amp.
FAS Rhythm.....	British + USA crunch	Combines the best features of the British and USA crunch models.
FAS Wreck	Trainwreck Express	Original WRECKER 1 model from the Axe-Fx Ultra.
Fox ODS ☞.....	Fuchs Overdrive Supreme-50	Dumble clone. Overdrive channel, 50w, 6L6 tubes. Preamp Bypass (PAB) active.
Fox ODS Deep ☞.....	Fuchs Overdrive Supreme-50	Deep switch ON.
Friedman BE	Friedman Brown Eye	50w or 100w, EL34. What many call "the ultimate modded Plexi" by Dave Friedman (Rack Systems).
Friedman HBE.....	Friedman Hairy Brown Eye.....	BE amp's alternate voicing with a gain boost. A killer hi-gain tone in your arsenal.
Fryette D60 L ☞.....	Fryette D60 (Less)	60w, KT88 or 6550 tubes. "Deliverance Sixty". "Less" mode.
Fryette D60 M ☞.....	Fryette D60 (More)	"More" mode.
Gibtone Scout ☞.....	Gibson Scout	1964 GA17RVT Scout, 17w, vintage clean tones. No tone controls on the real amp.
Herbie Ch2+.....	Diezel Herbert (Ch 2+).....	3-channel 180w, called "looser" and "more "familiar" than the VH4. Channel 2+ gets you into Diezel VH4 territory.
Herbie Ch2-.....	Diezel Herbert (Ch 2-)	Set Ch 2- at 35% gain for a cranked Plexi tone, 60% for a JCM800 tone.
Herbie Ch3	Diezel Herbert (Ch 3)	Channel 3.

Red amps are non-MV (no Master Volume on the real amp). The MASTER VOLUME is set to 10 by default.

☞ Includes the additional OVERDRIVE control.

⊗ The actual amp has a control labeled "Tone" which corresponds to TREB on the Axe-Fx. For a more realistic simulation, leave BASS and MID at noon.

☞ Amps with NEGATIVE FEEDBACK set to zero. PRESENCE is replaced with HI CUT. DEPTH is also disabled since it only affects negative feedback.

<u>AXE-FX AMP</u>	<u>BASED ON</u>	<u>DESCRIPTION</u>
Hipower Brillnt.....	Hiwatt DR103 (Brilliant).....	1974 Harry Joyce/Hylight model. Medium-gain, full sound with unique tone-stack and chimey, grinding tone.
Hipower Jumped.....	Hiwatt DR103 (Normal/Brilliant) ..	Emulates “jumpering the inputs” on a 4-hole amp.
Hipower Normal.....	Hiwatt DR103 (Normal).....	Normal channel.
Hot Kitty ☞.....	Bad Cat Hot Cat 30r (Ch 2)	30w, EL34, cathode bias, Channel 2. Voted by Guitar Player as “the second best combo of all time.”
Jazz 120.....	Roland JC-120.....	120w (stereo: 2x 60w). The only solid-state-based model in the collection, a quintessential clean tone.
JR Blues.....	Fender Blues Jr.	15w. A gutsy little classic with dual EL84s. To get the tone of an Egnater Rebel 20, set the Neg Fdbk to zero.
JR Blues Fat.....	Fender Blues Jr.	FAT switch engaged.
Matchbox D-30 ☞.....	Matchless DC-30.....	Matchless DC-30, 30w, Class-A, EL84s. A “better sounding” AC-30.
Mr Z Hwy 66.....	Dr. Z Route 66.....	32w, KT66, EF86 and 12AX7.
Mr Z MZ-38 ☞.....	Dr. Z MAZ 38 SR.....	38w, EL84 tubes. Popular with country and roots players. The quintessential country amp.
Mr Z MZ-8 ☞.....	Dr. Z MAZ 8.....	8w, EL84 tube. A popular low-wattage, single-ended amp. The actual amp can be run in Pentode or Triode mode.
Nuclear-Tone ☞.....	Swart Atomic Space Tone.....	20w, 6V6. As with the actual amp, the bias tremolo is particularly effective.
ODS-100 Clean.....	Dumble OD Special (Clean).....	100w “HRM” (Hot Rod Marshall) version, Clean channel. A coveted but rare amp made famous by Robben Ford.
ODS-100 Ford 1 ☞.....	Dumble OD Special (OD).....	“Non-HRM” version. Preamp Bypass ON. The default tone stack is neutral (with B/M/T at noon the response is flat.)
ODS-100 Ford 2 ☞.....	Dumble OD Special (OD).....	“Non-HRM” version. Preamp Bypass OFF.
ODS-100 Ford Md ☞.....	Dumble OD Special (OD).....	The same as ODS-100 Ford 1 with the Mid switch engaged.
ODS-100 HRM ☞.....	Dumble OD Special (OD).....	Lead channel matched with the preamp bypass (PAB) engaged (which bypasses the input tone stack) and the Drive control at approximately 7.0. Played by the great Larry Carlton and many others!
ODS-100 HRM Mid ☞.....	Dumble OD Special (OD).....	Lead channel with the “Mid” switch engaged (this switch is sometimes labeled “Deep”).
Plexi 100w High.....	Marshall Super Lead 1959.....	1968 model. Classic amp head that gave rise to “the stack.” Great for crunchy rhythm work. As with the real amp, don’t be afraid to turn the bass all the way down or the treble all the way up, or it’s too flubby. Treble channel.
Plexi 100w Jump.....	Marshall Super Lead 1959.....	Emulates “jumpering the inputs” on a 4-hole amp.
Plexi 100w Nrml.....	Marshall Super Lead 1959.....	Normal channel.
Plexi 50w High.....	Marshall Super Lead 1959.....	1972 model. Treble channel.
Plexi 50w Jump.....	Marshall Super Lead 1959.....	Emulates “jumpering the inputs” on a 4-hole amp.
Plexi 50w Nrml.....	Marshall Super Lead 1959.....	Normal channel.
Prince Tone ☞.....	Fender Princeton (Tweed).....	Class A, 5w. 5F2-A, AA964 circuits. Modeled after early CBS “Silverface” model, pre-CBS design and components.
Prince Tone NR ☞.....	Fender Princeton (no reverb).....	No reverb.
Prince Tone Rev ☞.....	Fender Princeton (reverb).....	1966 reverb.
PVH 6160 Block.....	Peavey EVH 5150 (Lead).....	120w, 6L6. An original block letter Peavey EVH 5150. Lead channel. It sounds way better than most 5150s partly due to the fact that this one has a bias mod so it’s biased a bit warmer than a stock version.
PVH 6160 II.....	Peavey 6505+.....	120w, 6L6. Identical to the EVH II.
Recto1 Org Mdrn ☞.....	Mesa Boogie 2 ch. Dual Rectifier ..	Orange channel, Modern mode. Presence control now operates like the actual amp in all Recto models. <i>For those models where there is no negative feedback, the Presence control is part of the tone stack (not a Hi Cut control.)</i>
Recto1 Org Norm.....	Mesa Boogie 2 ch. Dual Rectifier ..	Orange channel, Normal mode. Warmer and less fizzy than the 3 channel model.
Recto1 Red Mdrn ☞.....	Mesa Boogie 2 ch. Dual Rectifier ..	Red channel, Modern mode.
Recto2 Org Mdrn ☞.....	Mesa Boogie 3 ch. Dual Rectifier ..	Orange channel, Modern mode.
Recto2 Org Vntg.....	Mesa Boogie 3 ch. Dual Rectifier ..	Orange channel, Vintage mode.
Recto2 Red Mdrn ☞.....	Mesa Boogie 3 ch. Dual Rectifier ..	Red channel, Modern mode.
Recto2 Red Vntg.....	Mesa Boogie 3 ch. Dual Rectifier ..	Red channel, Vintage mode.
Ruby Rocket ☞.....	Paul Ruby Rocket.....	Paul Ruby Rocket is based on a Trainwreck Rocket but with some notable differences (also similar to a Vox AC30).
Shiver Cln.....	Bogner Shiva (Clean).....	90w, KT88. 20th anniv. Clean channel, powerful shimmering cleans. Dark amp, turn up Presence or engage Bright.
Shiver Ld.....	Bogner Shiva (Lead).....	Lead channel, sweet, rich-sounding amp with aggressive, English-style midrange punch.

Red amps are non-MV (no Master Volume on the real amp). The MASTER VOLUME is set to 10 by default.

☞ Includes the additional OVERDRIVE control.

☞ The actual amp has a control labeled “Tone” which corresponds to TREB on the Axe-Fx. For a more realistic simulation, leave BASS and MID at noon.

☞ Amps with NEGATIVE FEEDBACK set to zero. PRESENCE is replaced with HI CUT. DEPTH is also disabled since it only affects negative feedback.

<u>AXE-FX AMP</u>	<u>BASED ON</u>	<u>DESCRIPTION</u>
Solo 100 Clean	Soldano SLO-100 (Nrml/Clean)	SLO = Super Lead Overdrive, 100w. Normal channel, Clean gain selector.
Solo 100 Lead	Soldano SLO-100 (Lead)	Snarling Lead channel. This amp likes to be run hard, so the MV defaults to a higher setting than on most other amps (high MV helps thicken up the mids). To achieve the best sound, also back off the preamp gain.
Solo 100 Rhy	Soldano SLO-100 (Nrml/Crunch)	Normal channel, Crunch gain selector. Aggressive rhythm.
Solo 88 Lead	Soldano X88R preamp (Rhythm)	Lead resp. rhythm channel of a Soldano X88R preamp, 6L6
Solo 88 Rhythm	Soldano X88R preamp (Rhythm)	Rhythm channel.
Solo 99 Clean	Soldano X99 preamp (Clean)	Soldano/Caswell midi-motorized X99 preamp; Clean channel.
Solo 99 Lead	Soldano X99 preamp (Lead)	Lead channel.
Spawn Nitrous	Splawn Nitro (OD)	100w, KT-88, OD channel. Splawn tone with more saturation and voiced for a bigger low end and low mids.
Spawn Rod OD1-1	Splawn Quick Rod (1st gear)	100w, EL34. Signature Splawn tone with lots of bite, strong mids and 3 gear versatility. 1st gear, "Hot Rod Plexi".
Spawn Rod OD1-2	Splawn Quick Rod (2nd gear)	2nd gear, "Hot Rod JCM 800".
Spawn Rod OD1-3	Splawn Quick Rod (3rd gear)	3rd gear, "Super Hot Rod 800".
Spawn Rod OD2-1	Splawn Quick Rod (1st gear)	1st gear; OD2 switches in a cathode bypass cap which increases the gain of that stage.
Spawn Rod OD2-2	Splawn Quick Rod (2nd gear)	2nd gear; same as above.
Spawn Rod OD2-3	Splawn Quick Rod (3rd gear)	3rd gear; same as above.
Suhr Badger 18	Suhr Badger 18w	18w version of this EL84-powered tube rectifier classic. Master Volume is VERY powerful at altering the tone.
Suhr Badger 30	Suhr Badger 30w	In comparison to the 18w, the 30w features a solid state rectifier.
Super 6G4	Fender Super 6G4	1960-1963 2x10 brownface, 40w.
Super Verb	Fender Super Reverb	Pre-CBS 1964 Blackface version of this 40w amp, AB763 circuit, Vibrato channel. To simulate the Blackface Pro Reverb model AA165, set Tonestack Type = Blackface and set Mid = 7-8 to emulate the fixed 6.8K mid resistor.
Supertweed	Fender Tweed series	Original SUPERTWEED model from the Axe-Fx Ultra. "Like a vintage Tweed amplifier on steroids."
Supremo Trem	Supro 1964T	Supro 1964T.
SV Bass	Ampeg SVT	300w, Super Vacuum Tube bass amp. Used for decades by famous bassists the world over.
Thordendal Mdrn	n/a	Based on Fredrik Thordendal's specifications.
Thordendal Vint	n/a	Based on Fredrik Thordendal's specifications.
Tremolo Lux	Fender AA763 Tremolux	6L6, high and low inputs, Normal and Vibrato channels.
Tube Pre	generic tube preamp	Completely neutral, low-gain tube preamp useful for "warming up" various sources.
Two Stone J35 1	Two-Rock Jet 35	35w, 6L6. Lead mode, Preamp Bypass ON, which bypasses the input tone stack for a more focused lead sound.
Two Stone J35 2	Two-Rock Jet 35	Lead mode, Preamp Bypass OFF.
TX Star Clean	Mesa Lone Star (Clean)	Clean channel, 50/100w, 6L6. Try with a BB Pre drive block.
TX Star Lead	Mesa Lone Star (Lead)	Lead channel.
USA Bass 400 1	Mesa Bass 400	Bass Shift OFF.
USA Bass 400 2	Mesa Bass 400	Bass Shift ON.
USA Clean 1	Mesa Boogie Mark IV (Rhy 1)	Somewhat neutral, clean-sounding model that can pushed into warm clipping. Rhythm 1 channel.
USA IIC+ Bright	Mesa B. Mark IIC+ (Lead)	Bright ON.
USA IIC+ Norm	Mesa B. Mark IIC+ (Lead)	US-made amp famous for its smooth overdrive sound; Bright OFF.
USA Lead	Mesa Boogie Mark IV (Lead)	Tight, focused, hi-gain sound. Great for fusion and rock leads. Bright OFF, Mid Gain OFF.
USA Lead +	Mesa Boogie Mark IV (Lead)	Bright OFF, Mid Gain ON.
USA Lead Brt	Mesa Boogie Mark IV (Lead)	Bright ON, Mid Gain OFF.
USA Lead Brt +	Mesa Boogie Mark IV (Lead)	Bright ON, Mid Gain ON.
USA Pre Clean	Mesa Boogie TriAxis preamp	Rhythm Green channel ("Vintage Fat Rhythm" or "old Black Face"), 6L6.
USA Pre Ld1 Red	Mesa Boogie TriAxis preamp	Lead 1 Red mode (TX-4 board.)
USA Pre Ld2 Grn	Mesa Boogie TriAxis preamp	Lead 2 Green mode (Mid Gain Mark IV Lead.)

Red amps are non-MV (no Master Volume on the real amp). The MASTER VOLUME is set to 10 by default.

⚡ Includes the additional OVERDRIVE control.

🔊 The actual amp has a control labeled "Tone" which corresponds to TREB on the Axe-Fx. For a more realistic simulation, leave BASS and MID at noon.

⊖ Amps with NEGATIVE FEEDBACK set to zero. PRESENCE is replaced with HI CUT. DEPTH is also disabled since it only affects negative feedback.

<u>AXE-FX AMP</u>	<u>BASED ON</u>	<u>DESCRIPTION</u>
USA Pre Ld2 Red †	Mesa Boogie TriAxis preamp	Lead 2 Red mode (shred.)
USA Pre Ld2 Ylw †	Mesa Boogie TriAxis preamp	Lead 2 Yellow mode (Classic MKII Lead.)
USA Rhythm	Mesa Boogie Mark IV (Rhy 2)	THE California crunch rhythm sound. Rhythm Channel 2 with Fat switch OFF.
USA Sub Blues	Mesa Subway Blues	20w, EL84.
Vibra-King ⌘	Fender Vibro-King	Fender Vibro-King, famous for crystal cleans and powerful overdrive.
Vibra-King Fat ⌘	Fender Vibro-King	Fat switch ON.
Vibrato Lux	Fender VibroLux Reverb	1963 Blackface model, 6L6. Early Dire Straits tone.
Vibrato Verb	Fender Vibroverb	40w combo that's great for clear or grinding cleans and gutsy blues. 6G16 circuit, Brownface era.
Vibrato Verb AA	Fender Vibroverb	AA763 circuit.
Vibrato Verb AB	Fender Vibroverb	AB763 circuit.
Wrecker Express	Trainwreck Express	Trainwreck Express.
Wrecker Lvrpool	Trainwreck Liverpool	Trainwreck Express preamp with a Trainwreck Rocket power amp. EL84 tubes.
Wrecker Rocket	Trainwreck Rocket	Trainwreck Rocket.

Red amps are non-MV (no Master Volume on the real amp). The MASTER VOLUME is set to 10 by default.

† Includes the additional OVERDRIVE control.

⊗ The actual amp has a control labeled "Tone" which corresponds to TREB on the Axe-Fx. For a more realistic simulation, leave BASS and MID at noon.

⌘ Amps with NEGATIVE FEEDBACK set to zero. PRESENCE is replaced with HI CUT. DEPTH is also disabled since it only affects negative feedback.

FACTORY CABINETS

1	1x6 Oval	39	4x12 1960B T75 (RW)	77	1x10 Prince Tone Black Mix	115	1x12 Nuclear Tone Mix
2	1x8 Tweed	40	4x12 1960B K120 (RW)	78	1x10 Prince Tone Silver Mix	116	1x12 Scumtone 25W Mix
3	1x10 Gold	41	4x12 1960B V30 (RW)	79	1x12 Junior Blues Mix	117	2x12 Boutique Mix
4	1x10 Blue	42	4x12 Hi-Power (RW)	80	1x12 Deluxe Verb Mix	118	2x12 SV Legend Mix
5	1x12 Tweed	43	4x12 Recto V30 (RW)	81	1x12 Deluxe Tweed Mix	119	1x12 AC-20 Dlx Mix (UR)
6	1x12 Black	44	4x12 Recto V30 (OH)	82	1x12 Vibrato Lux Mix	120	1x12 Roamer Mix (UR)
7	1x12 Blue	45	4x12 Solo V12 (RW)	83	1x12 Class-A 15w Blue Mix	121	1x12 Triptik Mix (UR)
8	1x12 E12L (RW)	46	4x12 Solo S12X (RW)	84	1x12 Division 13 Mix	122	2x12 Class-A Mix (UR)
9	1x12 Studio	47	4x12 German V30 (RW)	85	1x12 Hot Kitty Mix	123	2x12 Double Verb Mix (UR)
10	1x12 EMI Open Back (JM)	48	4x12 German Boutique	86	1x12 Hawaii Mix	124	4x12 5153 Mix #1 (UR)
11	1x12 Bludo Mix	49	4x12 PVH6160 (RW)	87	1x15 Tweed Pro Mix	125	4x12 5153 Mix #2 (UR)
12	1x12 Boogafunk E12L (OH)	50	4x12 Uber T75 (RW)	88	1x15 Empire Mix	126	4x12 Citrus Mix (UR)
13	1x12 Tweed Blue (RW)	51	4x12 Uber V30 (RW)	89	2x10 Super Tweed Mix	127	4x12 Lerxst Mix (UR)
14	1x12 Tweed Deluxe (RW)	52	4x12 Uber T75+V30 (RW)	90	2x10 Vibrato Lux Mix	128	4x12 Cali Mix (UR)
15	1x12 Brit Blue (RW)	53	4x12 Citrus V30 (RW)	91	2x12 Double Verb Mix	129	4x12 Recto Mix (UR)
16	1x12 Brit G12H30 (RW)	54	4x12 Mills 12K (OH)	92	2x12 Pro Verb Mix	130	4x12 Recto New Mix (UR)
17	1x15 Blues	55	4x12 SLM Blue (OH)	93	2x12 Class-A 30w Blue Mix	131	4x12 TV Mix #1 (UR)
18	1x15 Thunderbolt (RW)	56	4x12 SLM G65 (OH)	94	2x12 Class-A 30w Silver Mix	132	4x12 TV Mix #2 (UR)
19	2x12 Black	57	4x12 SLM H75 (OH)	95	2x12 Supremo Mix		
20	2x12 Brit	58	4x12 TV Mix C1 (Ck)	96	2x12 Santiago EJ1250 Mix		
21	2x12 Doubleverb D120 (RW)	59	4x12 TV Mix C4 (Ck)	97	2x12 Santiago Altec Mix		
22	2x12 Doubleverb C12N (RW)	60	4x12 20w	98	3x10 Vibrato King Mix		
23	2x12 Blue	61	4x12 25w	99	4x10 Bassguy Mix		
24	2x12 Top Boost Blue (RW)	62	4x12 V30	100	4x10 Super Verb Mix		
25	2x12 Top Boost Silver (RW)	63	4x12 German	101	4x12 Basketweave Green Mix		
26	2x12 Boutique (RW)	64	4x12 30w (Ultra)	102	4x12 Basketweave AX Mix		
27	2x12 Jazz (RW)	65	4x12 Cali	103	4x12 Basketweave TV Mix		
28	2x12 Gold 30 Far-Field (JM)	66	1x15 L.A. Bass	104	4x12 Cali Lead 80s Mix		
29	2x12 G12-65 Far-Field (JM)	67	4x10 Aluminum Bass (RW)	105	4x12 Rumble EV12L Mix		
30	2x12 Boutique	68	8x10 SV Bass (RW)	106	4x12 Rumble EV12S Mix		
31	2x12 Doubleshow (RW)	69	4x12 Pre-Rola Gb (UR)	107	4x12 PVH6160 Mix		
32	4x10 Tweed Bass	70	4x12 Beatle Gb (UR)	108	4x12 Petrucci V30 Mix		
33	4x10 Bassguy P10 (RW)	71	4x12 D120 (UR)	109	1x15 SV Bass M88 Mix		
34	4x12 Basketweave G12H30 (RW)	72	4x12 Sorcerer (UR)	110	1x15 SV Bass Subkick Mix		
35	4x12 Basketweave G12L (RW)	73	4x12 Ck USA Trad 57-121 (UR)	111	4x10 SV Bass M88 Mix		
36	4x12 Basketweave G12M20 (RW)	74	4x12 Ck USA Trad 906-421 (UR)	112	4x10 SV Bass Subkick Mix		
37	4x12 Basketweave G12M25 (RW)	75	1x8 Champlier Mix	113	4x10+Tweeter SV Bass M88 Mix		
38	4x12 1960A G12M (RW)	76	1x8 Vibrato Champlier Mix	114	1x12 AC-20 Dlx Mix		

Red cabs are UltraRes IRs. Blue cabs are far field IRs.

<u>AXE-FX CAB</u>	<u>DESCRIPTION</u>
1	1x6 Oval6" Supro, 6x9 oval speaker used in some early amps (Supro). Combine with a Plexi for some Zep.
2	1x8 Tweed1x8 Fender Blues Jr. Really thin and cutting for roots blues leads.
3	1x10 Gold1x10 Chicago Jensen C10N
4	1x10 Blue1x10 Alnico Blue
5	1x12 TweedFender 1x12 Tweed, based on the original 12" speaker used in an early Fender "Tweed".
6	1x12 BlackFender Blackface 1x12
7	1x12 BlueVox 1x12
8	1x12 E12L (RW)200w Electro-Voice EVM-12L, housed in a solid mahogany, open-backed cabinet.
9	1x12 StudioMesa Studio 22 1x12
10	1x12 EMI Open Back (JM)Far field IR (Eminence).
11	1x12 Bludo Mix1x12 Dumble dual port closed-back cab with an 8-ohm Blackhawk WGS Alnico speaker, similar in tone to an EVM-12L.
12	1x12 Boogafunk E12L (OH)Boogafunk Thiele 1x12 with Electro Voice EVM-12L Classic.
13	1x12 Tweed Blue (RW)Tweed Deluxe narrow panel from 1956 with replacement Celestion Alnico Blue speaker for brighter tone with more high end sparkle.
14	1x12 Tweed Deluxe (RW)Tweed Deluxe narrow panel from 1956 with the original Jensen P12R speaker for the purists. Rounder, warmer sound than the Blue.
15	1x12 Brit Blue (RW)Celestion Alnico Blue 12", IR of the speaker without a cabinet.
16	1x12 Brit G12H30 (RW)Celestion G12H30", IR of the speaker without a cabinet.
17	1x15 BluesPeavey Delta Blues 1x15
18	1x15 Thunderbolt (RW)Supro Thunderbolt S6420 cabinet with the original 15" Jensen speaker. Probably a Red Wirez IR. Decent low end for a small, open-backed cabinet, a boost around 550Hz that gives it some mid range "honk", and crunchy upper mids.
19	2x12 BlackFender Deluxe/Twin Reverb 2x12
20	2x12 BritVox AC30 with 2x12 Alnico Blue speakers.
21	2x12 Doubleverb D120 (RW)67 Fender Twin Reverb cabinet with vintage JBL D120Fs. The D120s have more low end than the C12Ns and a peak around 3700 Hz, for distinctly edgier upper mids.
22	2x12 Doubleverb C12N (RW)67 Fender Twin Reverb cabinet with vintage Jensen C12Ns. A little less bass than the D120s and a peak around 2500Hz which gives it a crunchier sound than the JBLs.
23	2x12 BlueChicago Jensen P12Q, two classic American 12" speakers with blue labels.
24	2x12 Top Boost Blue (RW)Vox AC30 with two Vox labeled Celestion Alnico Blues made in the UK. Chimey Vox goodness.
25	2x12 Top Boost Silver (RW)Vox AC30 with two Vox labeled alnico, silver speakers. These are 25 wattish, T1656 frame, Alnico silvers with Pulsonic cones made for the Thomas Organ Company in the 60's. Slightly less extended upper mids than the blues, same cones as the early greenbacks. Cool speakers in pristine condition.
26	2x12 Boutique (RW)Matchless ES212, with one custom voiced 30w Celestion G12H and one 25w Celestion G12M.
27	2x12 Jazz (RW)Roland Jazz Chorus JC-120 with Roland 12" speakers. Clean, kinda like a more scooped JBL D120.
28	2x12 Gold 30 Far-Field (JM)Far field IR of a Celestion Alnico Gold.
29	2x12 G12-65 Far-Field (JM)Far field IR of a Celestion G12-65.
30	2x12 BoutiqueMatchless 2x12
31	2x12 Doubleshow (RW)Fender Dual Showman cabinet with vintage JBL D130s.
32	4x10 Tweed BassFender 4x10 Bassman
33	4x10 Bassguy P10 (RW)Reproduction Narrow Panel Tweed Bassman cabinet with vintage '57 Jensen P10Qs. Crunchy upper mids, scooped low mids, and tons of low end below 70Hz.
34	4x12 Basketweave G12H30 (RW)68 Marshall Basketweave 4x12 with a matched quad of vintage, 30w, Celestion G12H "blackbacks." T1281 frames and "444", 55Hz bass cones from the late 70's. Unleash your inner Jimi, or Jimmy, if you prefer.
35	4x12 Basketweave G12L (RW)68 Marshall Basketweave 4x12 with vintage Celestion G12Ls.
36	4x12 Basketweave G12M20 (RW)68 Marshall Basketweave 4x12 with 20w Celestion Heritage G12Ms. Brown sound all around.
37	4x12 Basketweave G12M25 (RW)68 Marshall Basketweave 4x12 with vintage Marshall labeled 25w Celestion G12Ms. These beauties have T1221 frames and Pulsonic 003 "lead" cones.
38	4x12 1960A G12M (RW)Slant Marshall 1960 with four 25w Celestion G12Ms, aka "Greenbacks".
39	4x12 1960B T75 (RW)Straight Marshall 1960 with four Celestion G12T 75s.
40	4x12 1960B K120 (RW)Marshall 1960 cabinet with JBL K120s.

<u>AXE-FX CAB</u>	<u>DESCRIPTION</u>
41 4x12 1960B V30 (RW)Straight Marshall 1960 with four Celestion Vintage 30s.
42 4x12 Hi-Power (RW)1975 Hiwatt SE4123 cabinet with four vintage 50w Fane purplebacks.
43 4x12 Recto V30 (RW)Oversized Mesa Rectifier cabinet with four Celestion Vintage 30s.
44 4x12 Recto V30 (OH)Mesa Boogie Rectifier 4x12 with Celestion Vintage 30s.
45 4x12 Solo V12 (RW)Soldano 412B with four Eminence Legend V12s. A lot more high end than the S12X version. It's a front-loaded cab with lots of resonance so you may need to back the mics off a bit more than usual.
46 4x12 Solo S12X (RW)Soldano 412B with four Eminence made S12Xs. S12Xs were stock in the older cabs. Give this one a little more distance than you might normally, the cab resonance is pronounced up close and the speakers have a notch in the upper mids between 4-8KHz. Nice for taming fizzy guitars.
47 4x12 German V30 (RW)Bogner or ENGL Pro 4x12 cabinet with four Celestion Vintage 30s.
48 4x12 German BoutiqueENGL Pro 4x12 cabinet with four Celestion Vintage 30s.
49 4x12 PVH6160 (RW)Older model Peavey 5150 4x12 cabinet with four Sheffield 1200 speakers.
50 4x12 Uber T75 (RW)Bogner Uberkab, with Celestion G12T 75s + Vintage 30s. This IR features the T-75s.
51 4x12 Uber V30 (RW)Same as above. This IR features the V30s.
52 4x12 Uber T75+V30 (RW)Same as above. This IR is a 50/50 mix of both speakers.
53 4x12 Citrus V30 (RW)Straight Orange 4x12 (PPC412) with Celestion Vintage 30s.
54 4x12 Mills 12K (OH)Mills Acoustics Afterburner 4x12 with Celestion G12K-100 speakers.
55 4x12 SLM Blue (OH)SLM Electronics 4x12 with Celestion Alnico Blue speakers.
56 4x12 SLM G65 (OH)SLM Electronics 4x12 with Celestion Heritage G12-65 speakers.
57 4x12 SLM H75 (OH)SLM Electronics 4x12 with Scumback H75 speakers, similar to G12.
58 4x12 TV Mix C1 (Ck)4x12 Marshall 1960TV Slant Cab with G12M-25 Greenbacks (Cab Pack 8).
59 4x12 TV Mix C4 (Ck)4x12 Marshall 1960TV Slant Cab with G12M-25 Greenbacks (Cab Pack 8).
60 4x12 20wMarshall with 4x12 low power 20w Greenbacks.
61 4x12 25wMarshall with 4x12 25w Greenbacks, 1970's.
62 4x12 V30Generic 4x12 with Celestion V30 speakers.
63 4x12 GermanBogner 4x12
64 4x12 30w (Ultra)G12H30 from the Axe-Fx Ultra (previously in this slot: 4x12 Metal, an Engl 4x12 captured by Jocke Skog of the band Clawfinger).
65 4x12 CaliMesa Boogie traditional 4x12
66 1x15 L.A. BassSWR 1x15 bass amp cabinet
67 4x10 Aluminum Bass (RW)Hartke 4x10" bass cabinet with aluminum drivers.
68 8x10 SV Bass (RW)Ampeg SVT 810 Bass cab with stock SVT 10" speakers.
69 4x12 Pre-Rola Gb (UR)Marshall with 4x12 Pre-Rola greenbacks (Cab Pack 6).
70 4x12 Beatle Gb (UR)Vox Beatle 4x12 cabinet with greenbacks (Cab Pack 6).
71 4x12 D120 (UR)4x12 cabinet with JBL D120s (Cab Pack 6).
72 4x12 Sorcerer (UR)Wizard 4x12 (Cab Pack 6).
73 4x12 Ck USA Trad 57-121 (UR)4x12 Mesa Recto Traditional Straight Cab with V30's (Cab Pack 7).
74 4x12 Ck USA Trad 906-421 (UR)4x12 Mesa Recto Traditional Straight Cab with V30's (Cab Pack 7).
75 1x8 Champlier MixFender Champ with 8" speaker (Producer Pack).
76 1x8 Vibrato Champlier MixFender Vibro Champ with 8" speaker (Producer Pack).
77 1x10 Prince Tone Black MixBlackface Fender Princeton with 10" speaker (Producer Pack).
78 1x10 Prince Tone Silver MixSilverface Fender Princeton with 10" speaker (Producer Pack).
79 1x12 Junior Blues MixFender Blues Junior with 12" speaker (Producer Pack).
80 1x12 Deluxe Verb MixFender Deluxe Reverb with 12" speaker (Producer Pack).
81 1x12 Deluxe Tweed MixFender Deluxe Tweed with 12" speaker (Producer Pack).
82 1x12 Vibrato Lux MixFender Vibrolux with 12" speaker (Producer Pack).
83 1x12 Class-A 15w Blue MixVox AC-15 with 12" Alnico Blue (Producer Pack).
84 1x12 Division 13 MixDivided By 13 CJ 11 with 12" G12M (Producer Pack).
85 1x12 Hot Kitty MixBlack Cat Hot Cat 30R with 12" proprietary Celestion speaker (V30) (Producer Pack).

<u>AXE-FX CAB</u>	<u>DESCRIPTION</u>
86	1x12 Hawaii MixOhau cabinet (Producer Pack).
87	1x15 Tweed Pro Mix.....Fender Pro with 15" speaker (Producer Pack).
88	1x15 Empire Mix15" Eminence speaker (Producer Pack).
89	2x10 Super Tweed MixFender Super Reverb with two 10" speakers (Producer Pack).
90	2x10 Vibrato Lux MixFender Vibrolux with two 10" speakers (Producer Pack).
91	2x12 Double Verb Mix.....Fender Twin Reverb with two 12" speakers (Producer Pack).
92	2x12 Pro Verb Mix.....Fender Pro Reverb with two 12" speakers (Producer Pack).
93	2x12 Class-A 30w Blue MixVox AC-30 with two 12" Alnico Blue speakers (Producer Pack).
94	2x12 Class-A 30w Silver MixVox AC-30 with two 12" Alnico Silver speakers (Producer Pack).
95	2x12 Supremo Mix.....Supro with two 12" speakers (Producer Pack).
96	2x12 Santiago EJ1250 Mix.....12" Eminence EJ1250 50w speaker in a Fender closed-back cabinet (Producer Pack).
97	2x12 Santiago Altec Mix.....12" Altec 417-8H speaker in a x12 half-open cabinet (Producer Pack).
98	3x10 Vibrato King Mix.....Fender Vibro-King with three 10" speakers (Producer Pack).
99	4x10 Bassguy Mix.....Fender Bassman with four 10" speakers (Producer Pack).
100	4x10 Super Verb MixFender Super Reverb with four 10" speakers (Producer Pack).
101	4x12 Basketweave Green Mix.....Marshall cabinet with four 12" G12M (greenback) speakers (Producer Pack).
102	4x12 Basketweave AX Mix.....Marshall 1960AX (angled front) with four 12" (probably greenbacks) speakers (Producer Pack).
103	4x12 Basketweave TV MixMarshall 1960TV angled tall cabinet with four 12" (probably greenbacks) speakers (Producer Pack).
104	4x12 Cali Lead 80s MixMesa cabinet from the 80s with four Classic Lead 80 speakers (Producer Pack).
105	4x12 Rumble EV12L Mix.....EVM 12L speakers in a 4x12 12L/12S Dumble cabinet (Producer Pack).
106	4x12 Rumble EV12S Mix.....EVM 12S speakers in a 4x12 12L/12S Dumble cabinet (Producer Pack).
107	4x12 PVH6160 Mix.....EVH 5150 cabinet (Producer Pack).
108	4x12 Petrucci V30 Mix.....John Petrucci's Mesa 4x12 cabinet with V30s (Producer Pack). Adam Cook: "The Petrucci V30 Mix is pretty dark but that is the way he mics his cabs. It's a two mic blend and neither mic is particularly close to the center of the cab."
109	1x15 SV Bass M88 Mix1x15 bass cabinet, Beyerdynamic M88 microphone (Producer Pack).
110	1x15 SV Bass Subkick Mix1x15 bass cabinet, subkick (Producer Pack).
111	4x10 SV Bass M88 Mix4x10 bass cabinet, Beyerdynamic M88 microphone (Producer Pack).
112	4x10 SV Bass Subkick Mix4x10 bass cabinet, subkick (Producer Pack).
113	4x10+Tweeter SV Bass M88 Mix ...4x10 bass cabinet, M88 microphone (Producer Pack).
114	1x12 Class-A 20 Dlx Mix1x12 Morgan AC20 Deluxe cabinet (Producer Pack).
115	1x12 Nuclear Tone MixSwart Atomic Space Tone cabinet, open back, 1x12 Mojotone British Vintage Series BV-25m speaker (Producer Pack).
116	1x12 Scumtone 25W Mix.....Cas Azera Tone-Tools detuned 1x12 cabinet with Scumback H55 (Producer Pack).
117	2x12 Boutique Mix.....2x12 Matchless cabinet (Producer Pack).
118	2x12 SV Legend Mix.....Carvin Legacy 2x12 cabinet, closed back (Producer Pack).
119	1x12 AC-20 Dlx Mix (UR).....Morgan AC20 Deluxe cabinet (Cab Pack 4).
120	1x12 Roamer Mix (UR).....Carr Roamer cabinet (Cab Pack 4).
121	1x12 Triptik Mix (UR)Carol-Ann Triptik cabinet with Scholz Classic speaker (Cab Pack 5).
122	2x12 Class-A Mix (UR)Vox AC-30 cabinet (Cab Pack 4).
123	2x12 Double Verb Mix (UR)Fender Twin Reverb cabinet (Cab Pack 4).
124	4x12 5153 Mix #1 (UR).....EVH 5150 III cabinet (Cab Pack 5).
125	4x12 5153 Mix #2 (UR).....EVH 5150 III cabinet (Cab Pack 5).
126	4x12 Citrus Mix (UR).....Orange cabinet with V30s (Cab Pack 5).
127	4x12 Lerxst Mix (UR)Mojotone Lerxst ported cabinet with greenbacks, works well with Marshall Silver Jubilee (Cab Pack 5).
128	4x12 Cali Mix (UR).....Mesa cabinet with Classic 80 speakers (Cab Pack 4).
129	4x12 Recto Mix (UR).....Mesa Rectifier vintage cabinet (Cab Pack 5).
130	4x12 Recto New Mix (UR).....Mesa Rectifier standard cabinet (Cab Pack 5).
131	4x12 TV Mix #1 (UR)early 70's Marshall 1960 TV angled tall cabinet with four 12" speakers (Cab Pack 5).
132	4x12 TV Mix #2 (UR)early 70's Marshall 1960 TV angled tall cabinet with four 12" speakers (Cab Pack 5).

<u>AXE-FX AMP</u>	<u>SPEAKER TYPE</u>
1959SLP	G12M, G12H, G12L
1987x.....	G12M, G12H, G12L
5153.....	G12-EVH (G12H30)
59/65 Bassguy	4x10, 2x12
5F1 Tweed	8" speakers
AC-20 Dlx.....	Alnico Blue, G12H, Greenback
Angle Severe	V30
Atomica	G12H
Band-Commander	2x12 (Jensen C12N)
Blanknshp Leeds.....	2x10 Jensen C10Q, Alnico Blue
Bludojai	G12-65, EVM 12L
Boutique	G12M + G12H
Brit 800/Silver.....	G12M, G12H, V30, T75
Brit AFS100/Super	V30
Brit Brown	G12M, G12H, EVH
Brit JM45	G12M, G12H, G12L
Brit JVM	V30 + G12H
Brit Pre	(preamp)
Buttery	G12M, G12H
CA OD-2.....	EVM 12L or Celestion Classic Lead 80
CA Tucana 3	G12-65, V30, G12-75
CA3+	(preamp)
Cali Leggy	V30
Cameron	G12H
Car Roamer	12" Eminence Elsinore
Citrus A30, Terrier	G12H
Citrus RV50	V30
Class-A 15w/30w.....	Alnico Blue, G12M
Comet.....	Greenbacks, G12H, V30
Concert 6G12.....	4x10 Jensen P10R, P10Q, C10R
Corncob M50	60w V30
Das Metall	V30, G12K100
Deluxe Tweed.....	Jensen P12R, C12N, Alnico Blue
Deluxe Verb.....	1x12 (Jensen C12Q, EVM 12L, JBL D120), 2x10 (Jensen C10N, C10Q, P10R)
Dirty Shirley	V30, G12M, G12H
Div/13 CJ.....	G12M
Div/13 FT37.....	Alnico Blue + G12H30
Dizzy V4	V30, G12K100
Double Verb	2x12 (Jensen C12N, JBL D120, EVM-12L)
Energyball	V30, custom V60
Euro Blue/Red	V30
Euro Uber.....	V30 + G12T75 (Uberkab)
Fox ODS	G12-65, EVM 12L
Friedman	G12M, G12H, V30
Fryette D60.....	Eminence P50E
Gibtone Scout	1x10
Herbie.....	V30, G12K100
HiPower	4x12 Fane
Hot Kitty.....	Bad Cat proprietary Celestion
Jazz 120	2x12 "silver" Roland
JR Blues.....	Jensen C12N, P12R
Matchbox D-30	G12H30 + G12M
Mr Z Hwy 66.....	V30 + G12H

<u>AXE-FX AMP</u>	<u>SPEAKER TYPE</u>
Mr Z MZ-38, MZ-8.....	G12H
Nuclear-Tone	G12M
ODS-100.....	G12-65, EVM 12L
Plexi.....	G12M, G12H, G12L
Prince Tone	Jensen C10N
PVH 6160.....	Sheffield 1200
Recto.....	V30
Ruby Rocket	Alnico
Shiver	V30, G12M
Solo 88 Rhythm.....	(preamp)
Solo 99	(preamp)
Solo 100.....	12" Eminence
Spawn.....	G12M, G12-65, V30
Suhr Badger	V30
Super 6G4	2x10 Jensen P10R, P10Q, Oxford 10K5
Super Verb.....	4x10 Jensen C10R, C10Q, P10R
Supremo Trem	6" oval speaker, 12" or 15" Jensen
SV Bass	8x10
Tremolo Lux	2x10
Tube Pre.....	(preamp)
Two-Stone J35.....	G12-65
TX Star Lead	Mesa C90 (a modified CL80)
USA IIC+.....	EVM 12L
USA Pre.....	(preamp)
USA Sub Blues	10" Eminence Black Shadow
USA (all others)	Mesa C90 (a modified CL80)
Vibra-King	3x10
Vibrato Lux	2x10 (Jensen C10Q), Oxford 1x12
Vibrato Verb	1x15 (Jensen C15N, JBL D130, Eminence), 2x10 (Jensen C10Q)
Wrecker	G12M

Understanding All the Different Gain Controls

The amp block in the Axe-Fx has a variety of gain controls that change depending upon the amp model selected. These controls are:

Input Drive

Input Trim

Overdrive

Master Volume

These various controls are located at fixed points in the virtual amplifier circuit as follows:

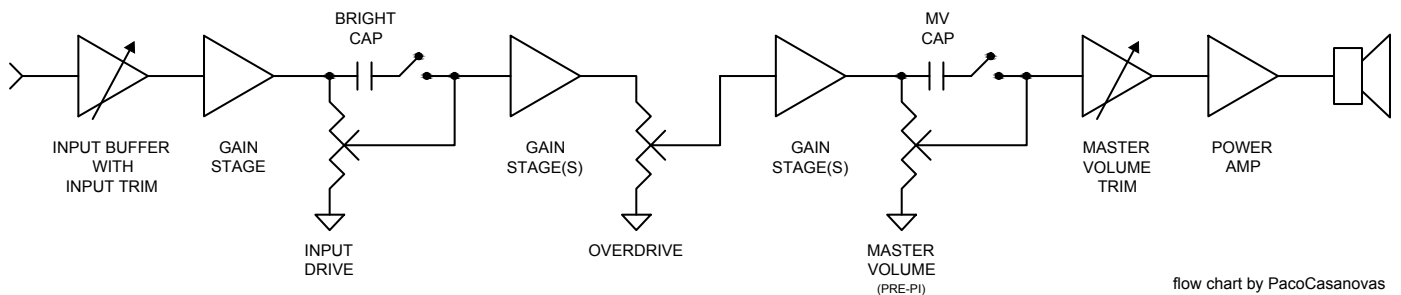

Input Drive

This is the modeled amp's gain, drive, volume, etc. control. It adjusts the attenuation at the input to the amplifier gain stages after the input buffer. On a Marshall Plexi, for example, it is the "Loudness" control. On a typical Fender amp it is the "Volume" control. On many high-gain amps it is called either "Gain" or "Drive".

On a real amp this is implemented using a variable resistor (potentiometer). Many amps include a "bright cap" on the drive control which is a small value capacitor placed across the terminals of the pot that bleeds treble frequencies through as the gain is reduced. Sometimes this bright cap is switchable via a switch on the amp. Sometimes it is fixed.

Input Trim

The Input Trim control adjusts the input attenuation without changing the frequency response. If you turn down the Input Drive and the model has a bright cap the amp will get brighter. Now you may like the brighter tone but wish there were more gain. Input Trim allows you to increase the gain without changing the tone. Conversely you may like the darker tone with Input Drive set high but wish there were less gain. In this case you can lower Input Trim.

Most real amps do not possess an Input Trim control. Instead they usually have a switch or two input jacks that select between a high-gain and low-gain input. Almost invariably the difference between these two jacks is 6 dB. All the Axe-Fx amps are modeled using the high-gain input or switch position (if any). To simulate the low-gain input set the Input Trim to 0.5 which is 6 dB less.

Overdrive

Some amps possess an attenuation control between the later gain stages. Examples of the are the Mesa/Boogie Mark series, Dumble ODS and others. This control allows the user to vary the gain staging. The Input Drive can be turned up and the Overdrive turned down so that the earlier stages distort more and the later stages distort less and vice-versa.

Master Volume

The Master Volume (MV) controls how much signal level is sent to the power amp. Many vintage amps have no MV control and the power amp runs "wide open". Modern amps often get their distortion from the preamp and the Master Volume then allows the user to control the volume of the amp.

The Master Volume in the Axe-Fx II, as well as on real amps, is probably the singular most powerful control in the amp block. As the Master Volume is increased the virtual power amp begins to distort. The virtual power amp also begins to sag and all sorts of beautiful magic occurs. The tone becomes more focused, the dynamic response changes, the note attack is accentuated, etc.

The key to crafting the ultimate tone involves understanding these controls and learning how to balance them.

<u>DRIVE BLOCK</u>	<u>DESCRIPTION</u>
BB Pre *	Xotic Pedals BB Preamp
Bender Fuzz	Classic Tonebender circuit
Bit Crusher	A black box we found lying in the trash outside Studio Harshclip
Blues OD	Marshall Bluesbreaker
Esoteric ACB	Xotic AC Boost
Esoteric RCB	Xotic RC Boost
Eternal Love *	Lovepedal Eternity
Face Fuzz	Dallas Arbiter Fuzz Face
FAS LED-Drive *	LED diodes have a higher voltage drop than silicon diodes
Fat Rat	Modified version of the Rat Dist; a bit fuller and smoother
FET Boost	Gentle, smooth clipping booster with tone controls
FET Preamp	
Full OD *	Fulltone Fulldrive OD Pedal
Hard Fuzz	Hard-clipping, 60s-style fuzz
M-Zone Dist	Boss Metalzone, popular for extreme gain settings
Master Fuzz	Maestro Fuzztone, aka Satisfaction fuzz
Mid Boost	Custom mid-boost overdrive
Octave Dist	Tycobrahe Octavia
PI Fuzz	Big Muff Pi Fuzz
Plus Dist	MXR Distortion Plus
Rat Dist	ProCo Rat Distortion
Ruckus	Suhr Riot Distortion
SDD Preamp	
Shred Dist	Marshall Shredmaster
Super OD *	Boss Super Overdrive
T808 MOD *	Captures the most popular 808 mods
T808 OD *	Ibanez TS-808 Tube Screamer
Tape Dist	Simulates the clipping of an overdriven reel-to-reel tape deck.
Treble Boost	Classic Treble Booster
Tube Drv 3-Knob	Chandler/Butler Tube Driver with a 12AX7, 3-knob version
Tube Drv 4-knob	4-knob version
Zen Master *	Hermida Zendrive

* based on the Tube Screamer

CC ASSIGNMENTS

sorted by function

<u>Function</u>	<u>CC</u>	<u>Function</u>	<u>CC</u>	<u>Function</u>	<u>CC</u>
Amp 1 Bypass	37	Filter 2 Bypass	53	Phaser 2 X/Y	113
Amp 1 X/Y	100	Filter 3 Bypass	54	Pitch 1 Bypass	77
Amp 2 Bypass	38	Filter 4 Bypass	55	Pitch 1 X/Y	114
Amp 2 X/Y	101	Flanger 1 Bypass	56	Pitch 2 Bypass	78
Bypass	13	Flanger 1 X/Y	110	Pitch 2 X/Y	115
Cab 1 Bypass	39	Flanger 2 Bypass	57	Quad Chorus 1 Bypass	79
Cab 1 X/Y	102	Flanger 2 X/Y	111	Quad Chorus 2 Bypass	80
Cab 2 Bypass	40	Formant 1 Bypass	58	Resonator 1 Bypass	81
Cab 2 X/Y	103	FX Loop Bypass	59	Resonator 2 Bypass	82
Chorus 1 Bypass	41	Gate/Expander 1 Bypass	60	Reverb 1 Bypass	83
Chorus 1 X/Y	104	Gate/Expander 2 Bypass	61	Reverb 1 X/Y	116
Chorus 2 Bypass	42	Graphic EQ 1 Bypass	62	Reverb 2 Bypass	84
Chorus 2 X/Y	105	Graphic EQ 2 Bypass	63	Reverb 2 X/Y	117
Compressor 1 Bypass	43	Graphic EQ 3 Bypass	64	Ring Modulator Bypass	85
Compressor 2 Bypass	44	Graphic EQ 4 Bypass	65	Rotary 1 Bypass	86
Crossover 1 Bypass	45	Input Volume	10	Rotary 1 X/Y	125
Crossover 2 Bypass	46	Looper Bypass	33	Rotary 2 Bypass	87
Delay 1 Bypass	47	Looper Dub	31	Rotary 2 X/Y	126
Delay 1 X/Y	106	Looper Half	120	Scene Increment	123
Delay 2 Bypass	48	Looper Once	30	Scene Decrement	124
Delay 2 X/Y	107	Looper Play	29	Scene Select	34
Drive 1 Bypass	49	Looper Record	28	Synth 1 Bypass	88
Drive 1 X/Y	108	Looper Rev	32	Synth 2 Bypass	89
Drive 2 Bypass	50	Looper Undo	121	Tempo	14
Drive 2 X/Y	109	Megatap Delay Bypass	66	Tone Matching	99
Enhancer Bypass	51	Metronome	122	Tremolo/Panner 1 Bypass	90
External Control 1	16	Multiband Comp 1 Bypass	67	Tremolo/Panner 2 Bypass	91
External Control 2	17	Multiband Comp 2 Bypass	68	Tuner	15
External Control 3	18	Multi Delay 1 Bypass	69	Vocoder Bypass	92
External Control 4	19	Multi Delay 2 Bypass	70	Volume Decrement	36
External Control 5	20	Out 1 Volume	11	Volume Increment	35
External Control 6	21	Out 2 Volume	12	Volume/Pan 1 Bypass	93
External Control 7	22	Parametric EQ 1 Bypass	71	Volume/Pan 2 Bypass	94
External Control 8	23	Parametric EQ 2 Bypass	72	Volume/Pan 3 Bypass	95
External Control 9	24	Parametric EQ 3 Bypass	73	Volume/Pan 4 Bypass	96
External Control 10	25	Parametric EQ 4 Bypass	74	Wahwah 1 Bypass	97
External Control 11	26	Phaser 1 Bypass	75	Wahwah 1 X/Y	118
External Control 12	27	Phaser 1 X/Y	112	Wahwah 2 Bypass	98
Filter 1 Bypass	52	Phaser 2 Bypass	76	Wahwah 2 X/Y	119

CC ASSIGNMENTS

sorted by CC

<u>Function</u>	<u>CC</u>	<u>Function</u>	<u>CC</u>	<u>Function</u>	<u>CC</u>
Input Volume	10	Drive 1 Bypass	49	Synth 1 Bypass	88
Out 1 Volume	11	Drive 2 Bypass	50	Synth 2 Bypass	89
Out 2 Volume	12	Enhancer Bypass	51	Tremolo/Panner 1 Bypass . . .	90
Bypass	13	Filter 1 Bypass	52	Tremolo/Panner 2 Bypass . . .	91
Tempo Tap	14	Filter 2 Bypass	53	Vocoder Bypass	92
Tuner	15	Filter 3 Bypass	54	Volume/Pan 1 Bypass	93
External Control 1	16	Filter 4 Bypass	55	Volume/Pan 2 Bypass	94
External Control 2	17	Flanger 1 Bypass	56	Volume/Pan 3 Bypass	95
External Control 3	18	Flanger 2 Bypass	57	Volume/Pan 4 Bypass	96
External Control 4	19	Formant 1 Bypass	58	Wahwah 1 Bypass	97
External Control 5	20	FX Loop Bypass	59	Wahwah 2 Bypass	98
External Control 6	21	Gate/Expander 1 Bypass	60	Tone Matching	99
External Control 7	22	Gate/Expander 2 Bypass	61	Amp 1 X/Y	100
External Control 8	23	Graphic EQ 1 Bypass	62	Amp 2 X/Y	101
External Control 9	24	Graphic EQ 2 Bypass	63	Cab 1 X/Y	102
External Control 10	25	Graphic EQ 3 Bypass	64	Cab 2 X/Y	103
External Control 11	26	Graphic EQ 4 Bypass	65	Chorus 1 X/Y	104
External Control 12	27	Megatap Delay Bypass	66	Chorus 2 X/Y	105
Looper Record	28	Multiband Comp 1 Bypass	67	Delay 1 X/Y	106
Looper Play	29	Multiband Comp 2 Bypass	68	Delay 2 X/Y	107
Looper Once	30	Multi Delay 1 Bypass	69	Drive 1 X/Y	108
Looper Dub	31	Multi Delay 2 Bypass	70	Drive 2 X/Y	109
Looper Rev	32	Parametric EQ 1 Bypass	71	Flanger 1 X/Y	110
Looper Bypass	33	Parametric EQ 2 Bypass	72	Flanger 2 X/Y	111
Scene Select	34	Parametric EQ 3 Bypass	73	Phaser 1 X/Y	112
Volume Increment	35	Parametric EQ 4 Bypass	74	Phaser 2 X/Y	113
Volume Decrement	36	Phaser 1 Bypass	75	Pitch 1 X/Y	114
Amp 1 Bypass	37	Phaser 2 Bypass	76	Pitch 2 X/Y	115
Amp 2 Bypass	38	Pitch 1 Bypass	77	Reverb 1 X/Y	116
Cab 1 Bypass	39	Pitch 2 Bypass	78	Reverb 2 X/Y	117
Cab 2 Bypass	40	Quad Chorus 1 Bypass	79	Wahwah 1 X/Y	118
Chorus 1 Bypass	41	Quad Chorus 2 Bypass	80	Wahwah 2 X/Y	119
Chorus 2 Bypass	42	Resonator 1 Bypass	81	Looper Half	120
Compressor 1 Bypass	43	Resonator 2 Bypass	82	Looper Undo	121
Compressor 2 Bypass	44	Reverb 1 Bypass	83	Metronome	122
Crossover 1 Bypass	45	Reverb 2 Bypass	84	Scene Increment	123
Crossover 2 Bypass	46	Ring Modulator Bypass	85	Scene Decrement	124
Delay 1 Bypass	47	Rotary 1 Bypass	86	Rotary 1 X/Y	125
Delay 2 Bypass	48	Rotary 2 Bypass	87	Rotary 2 X/Y	126

EVH 5150 III 100w AMP
recommended settings from the manual
red dots indicate Eddie's personal settings

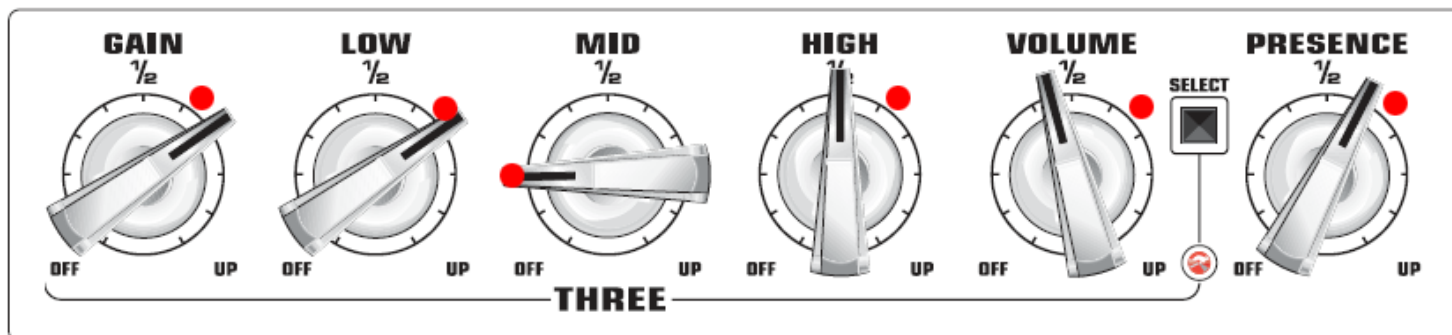
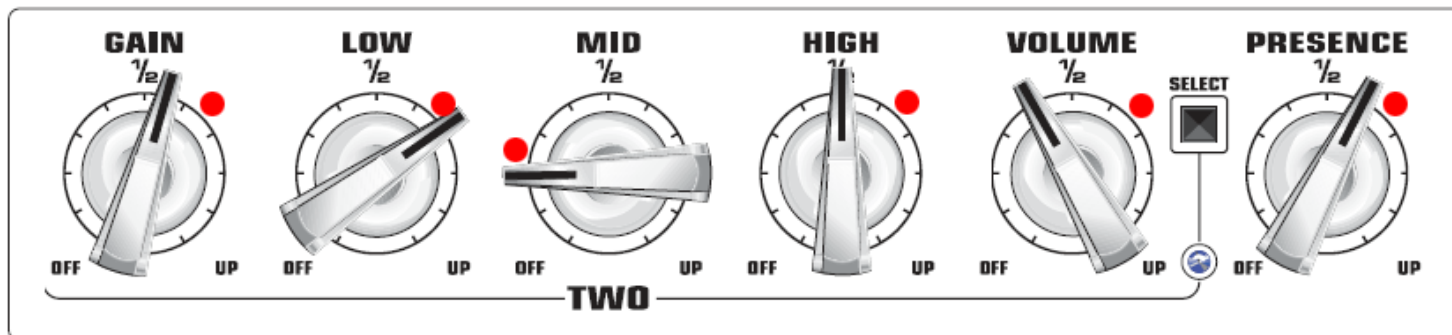
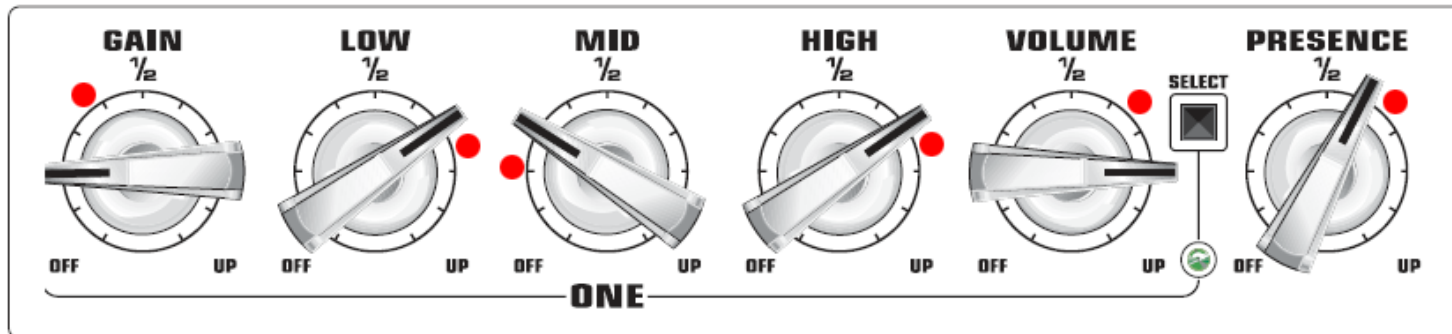

REVISION HISTORY

Red text in a parameter description indicates a new function not yet accessible in Axe-Edit.

2015-03-12 – Firmware 18.00 update, Axe-Edit 3.1.5 update. Parameters removed: Pwr Amp Low Cut/Hi Cut, Character Type/Q/Freq/Amt, Amp Voicing.

2015-01-17 – Added Cliff's gain controls guide with flow chart by PacoCasanovas.

2014-12-24 – Firmware 17.03 update.

2014-12-14 – Firmware 17.02 update, Axe-Edit 3.1.4 update.

2014-12-04 – Firmware 17.00 update, Axe-Edit 3.1.3 update.

2014-11-11 – Firmware 16.04 update, Axe-Edit 3.1.2 update.

2014-10-15 – Firmware 16.02 update, Axe-Edit 3.1.1 update.

2014-07-18 – Firmware 15.03 update.

2014-06-24 – Firmware 15.02 update, Axe-Edit 3.0.11 update.

2014-06-20 – Firmware 15.00 update, Axe-Edit 3.0.10 update.

2014-04-15 – Firmware 14.02 update.

2014-04-03 – Firmware 14.00 update, Axe-Edit 3.0.7 update.

2014-03-01 – Firmware 13.07 update, Axe-Edit 3.0.6 update.

2014-02-08 – Firmware 13.01 update, Axe-Edit 3.0.4 update.

2014-01-09 – Firmware 12.03 final.

2014-01-05 – Firmware 12.03 beta 5 update.

2013-12-23 – Firmware 12.03 update.

2013-11-09 – Axe-Edit 3.0.3 update with higher resolution screenshots more suitable for printing.

2013-11-08 – Firmware 12.00 update.

2013-10-10 – Firmware 11.04 update.

2013-09-05 – Firmware 11.02 update, Axe-Edit 3.0.1 update.

2013-09-02 – Firmware 11.01 update. Added 1987X Jump amp model and MV CAP parameter in the Amp block.

2013-08-30 – Updated the description of the COMP parameter. Added setting changes specific to jumpered amps.