

# AXE-FX II



## Amp & Cab Quick Reference Guide for Axe-Edit

Amp and cab block parameters explained  
Amp and cab descriptions  
Recommended speaker type for each amp  
Cliff's Gain Controls Guide  
Drive block descriptions  
CC assignments sorted by function & CC

content compiled from the Axe-Fx II manual, Wiki and forum suggestions, corrections, etc.: send a PM to JMA at the Fractal Audio forum

firmware Quantum v4.00 ~ Axe-Edit v3.8.1 ~ rev. August 18, 2016



## TOP ROW

**INPUT DRIVE** – Also known as Drive, Volume, Gain, etc. It is the knob closest to the input jack. In many cases it has a bright cap so the frequency response will be dependent on the knob position. As the gain increases the tone shifts from a treble and upper mid emphasis to a bass and lower mid emphasis. On jumped amps, this setting's label changes to **TREBLE DRIVE**.

**OVERDRIVE** – A second drive control for some amp models. It does not have a bright cap so it only affects the gain. Set Overdrive to 8.00 to get the identical response to pre-v10.10 firmware for models that have Overdrive. On jumped amps, this setting's label changes to **NORMAL DRIVE**.

**BASS/MID/TREB** – “Passive” tone stack. Can be changed with **TONESTACK TYPE**.

For most tone stacks, when you set the **BASS** and **TREB** to zero, the tone stack becomes basically “flat” and the **MID** becomes a volume control.

**BRIGHT** – High treble control shelving filter between the preamp and power amp. It may be used to darken or brighten the output of the preamp. It accurately replicates the “Presence” control found in the Mesa Triaxis preamp when set to negative values. (In the Triaxis, it is actually a high frequency cut shelving filter.)

**PRESENCE** – Decreases high frequency negative feedback in the power amp. Increase it to help sound cut through a heavy mix. Decrease it to compensate for overly-bright amps. It is tightly coupled to speaker impedance (**HI FREQ**, **HI RESONANCE**.)

**HI CUT** – On amps with no negative feedback, Presence is replaced with Hi Cut, a simple high-shelf EQ at the power amp output. (Hi Cut control is non-functional in Suhr models.)

**DEPTH** – Boosts low frequencies from the power amp by varying the negative feedback frequency response. Amps with a fixed depth circuit have a preset value. Amps with no depth circuit default to zero (Fenders, most Marshalls, and generally most older designs). Also called “Resonance” or “Girth” on some amps. **NOTE:** Depth is non-functional on most of the USA amp models due to the unique topology of their feedback networks.

**PRESENCE** and **DEPTH** differ from **BASS**, **TREBLE**, and **BRIGHT** in that they are applied to the power amp as opposed to the preamp. Their effect is dependent on the amount of **NEGATIVE FEEDBACK**.

**MASTER VOLUME** – Determines the amount of power amp distortion. As it increases, the tone controls have less influence on the sound. Amp models default to a starting Master Volume setting when selected.

**MASTER VOLUME** defaults to 10 for non-master volume (vintage) amps. If you want more MV on non-MV amps, increase **MASTER VOL TRIM**.

Most MV amps achieve full volume between 2-4. Further increase compresses the bass and treble, thereby adding mids. (Bass and treble are boosted by the speaker impedance curve, so they clip earlier.) The sweet spot is that point at which the power amp starts to compress. If you want a more “open” sound, be careful not to set the MV too high. You can also lower **XFORMER MATCH** (a little goes a long way). You can increase **LEVEL** to compensate for low MV.

Cliff: The way I dial in the MV is to turn it up until the amp stops getting louder. This is the point at which the power amp is saturating heavily. Then I back it off until I get the right amount of preamp and power amp distortion. That's the sweet spot where you get the tone and the dynamics. Too little MV and it's all preamp distortion and there's not much dynamics. Too much MV and the power amp is clipping too much and it can get flubby and/or harsh.

## BOTTOM ROW

**INPUT TRIM** – A clean, linear gain applied at the input to the amp block that adjusts the relative gain of the preamp. (This is analogous to changing the type of tube for V1 in an actual amp.) It does the same thing as the **BOOST** switch, the difference being that you can control how much is boosted or cut (+/-20 dB). As a rule of thumb, every 2x multiplier equals +6dB boost. In other words, Input Trim at 4.0 produces a +12dB boost. Input Trim should be set to 1.00 if you want to match the actual amp.

You can also adjust preamp gain globally with **GLOBAL AMP GAIN**, which affects every amp and preset. One reason you might do this is to compensate for the gain difference when switching to a hotter/quieter guitar.

On the Axe-Fx unit: **GLOBAL** button > **CONFIG** > **AMP GAIN**

**BOOST** – Toggles the input boost for an additional 12 dB of input gain. Enabling Boost sometimes works better than turning up **INPUT TRIM**.

**CUT** – Reduces the amount of low frequencies into the amp. This can be used to achieve a tighter tone or to reduce low-end “flub”. This is similar to increasing **LOW CUT** (Preamp page) while still retaining some low end so it doesn't get thin. Provides an easy way to cut the overpowering bass in models such as Recto, Splawn Nitro, Komet and others.

**FAT** – Emphasizes midrange “body” by shifting down the tone stack center frequency. Specifically, it multiplies the tone stack treble capacitor by four. Depending upon the type of tone stack, tone control settings, position, etc., the effect can be more or less noticeable. (See **TONE** page.)

**BRIGHT SWITCH** – Engages a capacitor across the drive pot. It is a “treble peaker” which functions mainly to compensate for the loss of highs at low amp volume. The effect may be subtle or pronounced, depending on the amp selected, and it is also affected by the **BRIGHT CAP**.

**BRIGHT CAP** – Sets the value of the capacitor which determines the sonic effect of the **BRIGHT** switch. Increase to make the preamp brighter and vice-versa.

**SATURATION SWITCH** – Switches in a zener diode clipping stage between the preamp and the tone stack (the “Arrendondo Mod”) for more aggressive distortion character which also adds compression and cuts volume.

**AUTH** – replicates authentic saturation circuit behavior and lowers the volume out of the virtual preamp.

**IDEAL** – replicates the idealized behavior from firmware v14.xx and earlier.

**SATURATION DRIVE** – Controls the amount of saturation.

**SATURATION** changes the distortion character. To preserve the distortion character and tone use **BOOST** or **INPUT TRIM** instead.

**MASTER VOL TRIM** – Can be used to increase (or decrease) the Master Volume for non-MV amps. If MV is 10 and you set MV Trim to 2.0 then the MV will be 20.

To correct “flubby” bass, decrease **MASTER VOLUME** or increase **PWR AMP HARDNESS**.



## TOP ROW

**PREAMP TUBE TYPE** – There are six extremely accurate preamp tube types: 12AX7A, 12AX7B, ECC83, ECC803, 7025, and EF86. Note that the EF86 type has been normalized to have roughly the same gain as the triode types.

**PREAMP BIAS** – Controls the bias point of the last triode (cathode follower not counted) in the preamp. Depending on the bias points of the previous stages increasing or decreasing this value can alter both the harmonic content (the ratio of even/odd harmonics) and the attack characteristics. The further you move away from (roughly) zero the more even harmonics are introduced. It's an asymmetric transfer function so you have to experiment. Typically, if the previous stage has a negative bias then increasing this value will be more noticeable and vice-versa. Use with **PREAMP HARDNESS**.

**PREAMP HARDNESS** – Controls how sharply the triodes enter saturation and can be used to simulate softer/harder tubes. The effect is subtle and most apparent at edge of breakup. Lower values give softer saturation and will sound softer (naturally) but have less note separation. Preamp Hardness at zero gives a smoother distortion with reduced upper harmonics. Higher values give a more aggressive breakup and better note separation.

**PREAMP TUBE TYPE, PREAMP BIAS, and PREAMP HARDNESS** are the primary controls that affect saturation behavior.

**TRIODE1/2 PLATE FREQ** – Sets the cutoff frequency of the plate impedance for the next-to-last (triode 1) and last (triode 2) triode in the chain, which allows you to control the buzziness that sometimes occurs with higher gain settings. The capacitor across the triode's plate resistor is used to smooth the response and reduce noise. You can adjust the amount of capacitance, and the resulting frequency. Lowering the frequencies dials out sharpness and "fizz", making the tone smoother. (Also see **HIGH CUT FREQ** to reduce "fizz".)

**CRUNCH** – Makes things more crunchy. It controls the distortion texture when you hit a note or chord.

**COMP TYPE** – Selects the type of preamp compressor:

**AUTHENTIC** – Accurately models the compression in a tube amp. Bolder and looser than Ideal.

**IDEAL** – An idealized distorting compressor. More focused and has tighter bass than Authentic. High gain players may prefer the ideal type due to its tight character.

**CF COMP** – Controls the amount of preamp compression and sets the compression threshold of the cathode follower. Many models default to zero as they do not have measureable compression.

## BOTTOM ROW

### TONESTACK TYPE

**ACTIVE** – Gives each tone control  $\pm 12$  dB boost/cut making them more sensitive; they also will not interact with each other.

**DEFAULT** – Matches the tone stack with the selected amp type.

**[AMP]** – Replaces the default tone stack with one from another amp.

The tone stack is one of the main things that gives an amp its particular voice, as it shapes the frequency response pretty drastically.

For a flat tone stack, set the **TONESTACK TYPE** to Neutral with B/M/T at noon. This allows the flexibility of being able to boost or cut bass and treble.

With the BF Fixed Mid tone stack, the value of the virtual resistor is 6.8K when the Mid control is at noon.

### tone location

**PRE** – Places the tone stack at the input to the preamp.

**POST** – Places it between the preamp and power amp.

**MID** – Places it between the last two triode stages.

**END** – Places it after the power amp (which is impossible with a real amp).

The farther upstream you position the stack, the thinner the sound.

**MID** will sound chunkiest, with **END** being rather dark.

**tone freq** – Sets the center frequency of the tone controls. This control works whether you are using **PASSIVE**, **ACTIVE**, or substitute tone stacks.

**LOW CUT FREQ** – Reduces the amount of low frequency (10-1000Hz) before the preamp input. Use this is to tighten up a tubby bass end. Somewhere between 10-150Hz is generally where it will sound best for standard guitar tones. Also see **CUT** (Basic page).

In the design of some amps the **LOW CUT FREQ** is dependent upon the **DRIVE** setting. In these cases the **LOW CUT FREQ** parameter defaults to 10 Hz and the actual low cut filtering is calculated as part of the **DRIVE** function.

**HIGH CUT FREQ** – Reduces the amount of high frequency (2k-20kHz) after the preamp output. Lower the value to make your top end sound smooth and silky, raise it to make it brilliant and defined. (Also see **TRIODE PLATE FREQ** to reduce "fizz".)

**DEFINITION** – A basic "tilt EQ" located at the amp input. It changes the fundamental character of the amp from vintage to modern or vice-versa. Positive values increase the amount of upper overtone saturation, negative values reinforce lower harmonics.

**HARMONICS** – Softens preamp distortion when increased. Default is zero.

**MODELING VERSION** – Selects between firmware versions Q2.00, Q2.01, Q2.04, Q3.xx, and Latest. It affects values for Preamp Hardness, Preamp Bias, and Harmonics. Existing presets retain their modeling version after firmware updates.



## TOP ROW

**NEGATIVE FEEDBACK** – Controls the amount of negative feedback in the power amp. The feedback decreases output impedance, causing the amp to react less to the speakers (“damping”). Higher values give a brighter, tighter, punchier sound but can be harsh at very high MASTER levels. Lower values give a smoother, loose and gritty sound and feel.

Setting **NEGATIVE FEEDBACK** to 0 disables it and replaces the **PRESENCE** control with **HI CUT**. **DEPTH** is also disabled since it only affects negative feedback.

**PWR AMP HARDNESS** – Controls the hardness of the virtual power tube grid clipping.

Adjusting **PWR AMP HARDNESS** is often not noticeable because negative feedback around the power amp makes the distortion harder. You can make the power amp distortion softer by reducing **NEGATIVE FEEDBACK**.

To correct “flubby” bass, decrease **MASTER VOLUME** or increase **PWR AMP HARDNESS**.

**PWR AMP BIAS** – Controls the amount of power tube mismatch by adjusting the offset voltage of the virtual power amp. A value of zero produces nearly symmetrical clipping which will produce very little even harmonics. Higher values will produce increasingly asymmetrical clipping which increases the amount of even harmonics. Small amounts of even harmonics can make the power amp distortion sound “warmer” and more bell-like while higher amounts will give a “fuzzier” tone.

**BIAS EXCURSION** – Grid modeling parameter that controls how much the power tube grid voltage droops when the grids conduct.

**CATHODE RESISTANCE** – Sets the amount of bias shift due to cathode voltage rise. (Zero defeats the cathode squish modeling.) It improves the feel of cathode-biased power amp models (Class-A, Mr Z, etc.)

**MV CAP** – Sets the value of the bright cap across the Master Volume pot. Setting it to 1.0 pF disables it.

**PRESENCE FREQ** – Alters the center frequency of the amp’s **PRESENCE** control.

**DEPTH FREQ** – Alters the center frequency of the amp’s **DEPTH** control.

## BOTTOM ROW

**POWER TUBE TYPE** – Selects a specific power tube type and sets **DYNAMIC DAMPING**. This doesn’t change the sound in the same way actually changing tubes would because it only changes the distortion curves, not the transconductance. In real amps, an EL34 has more than twice the transconductance of a 6L6. This means the plate current will be twice as great for a given grid voltage. This makes EL34s sound “more midrangey” and 6L6s sound “tighter” or “fuller”.

**MV LOCATION** – Location of the Master Volume.

**PRE-PI** – Before the phaser inverter (most amps).

**POST-PI** – After the phase inverter (AC types). This causes the PI to clip before the grids (if the MV is less than full). This creates a very aggressive and open sound.

**PRE-TRIODE** – Amp types based on Hiwatt models.

**POST-PI MV** turns a lot of mid-gain amps into ripping monsters. The only caveat is that, like a real amp, the more you turn the MV down the less effective **Presence** and **Depth** become (since the loop gain is reduced).

**PRESENCE SHIFT** – Only available on Mesa Boogie Mark IV’s with a “Pull Shift” on the **Presence** knob (USA **LEAD** and USA **RHYTHM**). When engaged, it normalizes the amount of high frequencies produced in the power section. **PRESENCE** will be more effective and will act on a higher frequency range. Note that it may result in volume reduction since the negative feedback is increased which lowers the loop gain.



### TOP ROW

**SUPPLY SAG** – Controls power supply impedance. Higher settings simulate higher power supply impedance, causing greater tube plate voltage (B+) “droop” and giving a more compressed, spongy and looser feel. Sag interacts with the MASTER: as the power amp is pushed and draws more current from its power supply, Sag has more effect. Sag values around 2 simulate a solid-state rectifier, 4-6 a tube rectifier.

In general, the more heavily driven the power amp section is, the more effect the SUPPLY SAG has. Setting SUPPLY SAG to 0 disables the power amp and turns the MASTER into a simple level control with a 40 dB range.

**AC LINE FREQ** – Selects the line frequency.

**B+ TIME CONSTANT** – Associated with SUPPLY SAG. Controls rate of change in power tube plate supply (in other words, the supply sag response time). “B+” refers to one of the high voltage “taps” or outputs of the main power transformer. Lower values give a bouncier feel, while higher values give a tighter, more aggressive feel. The effect of lower B+ is equivalent to increasing XFORMER MATCH. A lower B+ means the plates clip sooner which is the same as increasing the turns ratio on the transformer. This is assuming that you rebias since typically lower the B+ affects the bias.

**VARIAC** – AC voltage control that sets the relative AC line voltage into the amp simulation implementing a virtual “Variac”. Note that normally the volume would vary with the Variac setting in a real amp but the simulation compensates for the volume change by applying the inverse. This mitigates having to manually compensate using the Output Level.

**POWER AMP GRID BIAS** – Sets the quiescent operating current of the virtual power tubes. Increase it to reduce crossover distortion and vice-versa. Lower values approach pure Class-B operation. Higher values approach pure Class-A.

Increase POWER TUBE BIAS to thicken clean tones; reduce it to add aggression to high-gain sounds. A value of 0.5 or so will run the virtual tubes at around 75% of full power and clean tones will sound warmer but you will lose that sizzle on high-gain tones.

**TREMOLO FREQ/DEPTH (bias tremolo)** – Works by varying the bias of the virtual power tubes, resulting in a particularly “organic” sound. Most importantly, the tremolo is “self-ducking” and decreases at higher signal amplitudes. On some amps high values of bias trem depth can result in excessive crossover distortion. On others, the tremolo can vary greatly between loud and soft playing.

### BOTTOM ROW

**PREAMP SAG** – OFF replicates the behavior of separate preamp and power amp. ON replicates the behavior of an integrated tube head or combo amp.

**POWER TYPE** – When set to AC, models AC rectification and resulting supply ripple. High SUPPLY SAG along with low B+ TIME CONSTANT can cause “ghost notes” when the supply type is AC (as in a real amp). Lower B+ Time Constant values will make the amp feel “faster” but too low can cause ghost notes.



### TOP ROW

**LOW RES FREQ/Q/RESONANCE** – Guitar loudspeakers have a low-frequency resonance, typically about 100 Hz. This shifts up slightly when the speaker is mounted in an enclosure and is typically lower for open back cabs. This resonance causes an increase in the power amplifier response due to the finite output impedance of the power amp. The default LF Resonance is based on the cab most likely to be used with that amp. The Low Resonance parameter can be used to increase or decrease the amount of “thunk” or “knock”.

Don't be afraid to turn LOW RESONANCE close to 10. In fact, some Celestion and Eminence speakers are equivalent to about 8-9 on LOW RESONANCE. This will increase the interaction between the power tubes and the speaker load.

**HI FREQ** – Sets the “corner frequency” of the speaker impedance rise due to voice-coil inductance. The speaker voice-coil presents an inductive load to the power amp at high frequencies. This inductive load, in conjunction with the output transformer capacitance, creates a high-frequency resonance. Typical guitar speakers have a corner frequency between 1 kHz and 2 kHz. Lower values give more midrange emphasis.

**HI FREQ SLOPE** – Allows fine adjustment of the high-frequency impedance of the virtual voice coil (which affects the slope of the impedance curve). Reducing the Slope simulates a speaker that is less inductive, increasing Slope simulates a speaker that is more inductive. Typical speakers range from 3.0 to 4.5 with the median being about 3.7. Lower values yield greater midrange while higher values are more scooped and sizzly.

**HI RESONANCE** – Similar to HI FREQ but this control only changes the slope of the resonance. Default value is consistent with typical “semi-inductance” of speaker voice-coil. Varying this value will change the high-frequency load presented to the power tubes.

### BOTTOM ROW

**XFORMER LOW/HIGH FREQ** – These set the output transformer bandwidth.

**XFORMER MATCH** – One of the most powerful controls in the amp block. It changes the turns ratio (and therefore the primary impedance) of the output transformer, which controls how easily power tubes are driven into clipping. Decreasing causes the power tubes to clip later, the phase inverter and grid clipping become more predominant, and the speaker resonance will be more pronounced. You also reduce the power tube compression of the lows and highs. This control has more influence with higher MASTER values and low gain amps and less influence with highly compressed amps. Increase MASTER until desired amount of power amp distortion is achieved, then adjust XFormer Match for sound's character: higher = more compressed, lower = more open. The LF/HF RESONANCE parameters interact strongly with this parameter.

Use XFORMER MATCH to intentionally mismatch speaker impedance in order to get a different tone. To simulate plugging an 8-ohm speaker into a 4-ohm jack, set it to 2.0. For the other way around, set it to 0.5.

**XFORMER DRIVE** – Sets the amount of core saturation in the output transformer, controlling how hard the transformer is driven. Higher values simulate a smaller, more easily saturated transformer.

**XFORMER GRIND** – Controls the intensity of the dynamic core loss and leakage inductance effects of the output transformer modeling. Higher values result in more high frequency response and a more “open” sound. Very high values can yield a raspy, spitty tone common in vintage and/or low wattage amps. Modern “big iron” amps tend to have low values. The audibility is dependent upon how hard the virtual power amp is driven and is more noticeable as the MV is increased. The effect in real amps is highly dependent on the speaker: some speaker/transformer combinations exhibit significant high frequency dynamic boost while other combinations yield almost none.

**SPEAKER DRIVE** – Simulates distortion caused by pushing a speaker too far. It interacts with the MASTER.

The SPEAKER page is not an EQ. It allows you to adjust the impedance that the virtual speaker presents to the virtual power tubes. For a guitar amp with no negative feedback, the voltage frequency response of the power amp will very closely match this since the power amp is basically a current source. For a guitar amp with negative feedback, the resulting EQ is quite different than the impedance curve since negative feedback flattens the response. If you turn NEG FDBK all the way down then the EQ will be close to the impedance curve (but still influenced by the transformer.)



## TOP ROW

**CHARACTERTYPE** – Selects between a shelving behavior, peaking behavior, and Dynamic behavior. (With Dynamic, the character settings are engaged by playing harder. It can be used to fatten or scoop the tone as a function of picking strength.)

**CHARACTER FREQ/AMT** – These two parameters control powerful “inverse homomorphic filters”. When playing softly this dynamic filter has little effect on the sound. As the amount of distortion increases, the influence of the filter increases. The Character Freq control sets the center frequency of the filter while the Character Amt control sets how pronounced the effect is. For example, to darken the tone when playing harder, one might set the frequency to 10 kHz and the amount to -5. Setting the amount to +5 will make the tone brighter when playing hard.

**CHARACTER Q** – Controls the bandwidth of the response when the peaking behavior is chosen.

**DYNAMIC PRESENCE** – Models the output transformer leakage inductance that results in a brightening of the tone when the power amp is pushed. Increasing this value results in a brighter response as the virtual power amp is pushed. When playing softly or at lower gains, the influence of this control is lessened. Note that this only affects the power amp modeling and is dependent on the degree of power amp overdrive. This control can also be set negative to cause the tone to darken when playing hard. This control can also be used to help “dial in” the sweet spot of an amp model. As the MV is increased an amp becomes more liquid, compressed and easier to play. However, the highs may get overly compressed causing the amp to sound too dark. The Dynamic Presence control allows you to get the desired power amp drive and liquid feeling and then bring the highs back without affecting the rest of the spectrum.

**DYNAMIC DEPTH** – Analogous to the Dynamic Presence control, this increases or decreases low frequencies when the virtual amp is being pushed. While real amps don’t display this behavior, it is a valuable tone-shaping tool.

**DYNAMIC PRESENCE/DEPTH** are distortion-sensitive. The more the waveform distorts (the harder you play) the more pronounced the depth or presence boost/cut. If you play lightly (assuming you aren’t using stupid amounts of gain) the controls won’t seem to do much. As you play harder the effect becomes greater.

**PREAMP CF TIME** – Sets the attack time of the compressor.

## BOTTOM ROW

**COMP TYPE** – Sets the mode of the Amp block’s output compressor:

**OUTPUT** – The previous type where the compressor acts on the output of the block.

**FEEDBACK** – Also compresses the block output but applies dynamics to the input of the block based on the output compression.

**OUTPUT COMP** – Leveling compressor (think LA-2A) specifically tailored to reduce the output dynamic range of the Amp block. It can also be used to simulate the compression you get from a dynamic microphone and/or some mic preamps. The parameter value is the compression ratio, which equals  $1 + 3 * \text{comp} / 10$ . Attack and release are fixed.

**COMP THRESHOLD** – Sets the level at which OUTPUT COMP reduces the amplitude of the audio signal when that level is exceeded.

**COMP CLARITY** – Adjusts the bass response of the input dynamics and can be used to add clarity to the bass.

**PREAMP DYNAMICS** – Controls the amount of preamp compression.

**PICK ATTACK** – Controls a sophisticated dynamic range processor that operates on leading edge transients. Negative values reduce pick attack while positive values enhance it.

**PREAMP CF RATIO** – Sets the maximum amount of compression, with lower values giving more compression.



#### TOP ROW

**CAB** – Loads a cabinet impulse response (IR). The older FAS and RW cabs were recorded with neutral mics. OH, Kalthallen, and the Mix/Producer Pack series have matching mics included in the IR.

**SPEAKER SIZE (NORMAL/HI RES ONLY)** – “Scales” the IR to simulate shrinking or enlarging of the speaker. This effect can be used to shift where the tone sits in a mix, or to create dramatic effects. Subtle settings (0.9-1.1) will sound most natural. UltraRes IRs do not support size warping, therefore, this parameter is disabled for UltraRes cabinets.

**DEPHASE<sup>1</sup>** – Controls a sophisticated process that removes the “phasiness” from IRs and can yield a more “in the room” experience. The higher the setting the more “character” you remove.

**MOTOR DRIVE<sup>1</sup>** – Models the effect of high power levels on speaker tone. Simulates the impedance and distortion effects that occur when the speaker is pushed hard. Be aware this setting adds a little compression as you increase it.

**LOW/HIGH CUT<sup>1</sup>** – Adjusts the cutoff point of first order low/high pass filters. Increase the Low Cut if the sound is too “bassy” or “boomy.” Decrease the High Cut for a darker cab tone. Common settings are 80-150 Hz for high pass, and 5-7 kHz for low pass.

#### BOTTOM ROW

##### MIC TYPES

57 DYN – Shure SM57  
 58 DYN – Shure SM58  
 421 DYN – Sennheiser MD 421 II  
 87A COND – Shure Beta 87A  
 U87 COND – Neumann U87  
 E609 DYN – Sennheiser e609 Silver  
 RE16 DYN – Electro-Voice RE16  
 R121 COND – Royer Labs R-121  
 D112 DYN – AKG D112  
 67 COND – Neumann U67  
 NULL – Allows PROXIMITY without a mic.  
 INVERT – Inverts the signal allowing for interesting effects in conjunction with the DELAY parameter.

**MIC** – Don’t feel that you have to add a mic unless you *want* to add EQ, which is basically what you would be doing.

**DELAY** – Delays the signal up to 1 second. With cab in stereo mode or with two cab blocks in parallel, delaying one cab relative to the other can achieve interesting comb filter effects. A common practice in studio recording is to use multiple mics on a speaker at different distances to intentionally introduce it. The effect is most pronounced when the cabs are summed to mono.

**PROXIMITY** – Causes an increase in bass or low frequency response as proximity is increased (closer to speaker). Disabled when MIC is set to None.

**PROXIMITY FREQ<sup>1</sup>** – Allows tuning the frequency range over which the proximity effect occurs.

**FILTER SLOPE** – Selects between first-order (6 dB/octave) or second-order (12 dB/octave) filters for the Low Cut and High Cut filters.

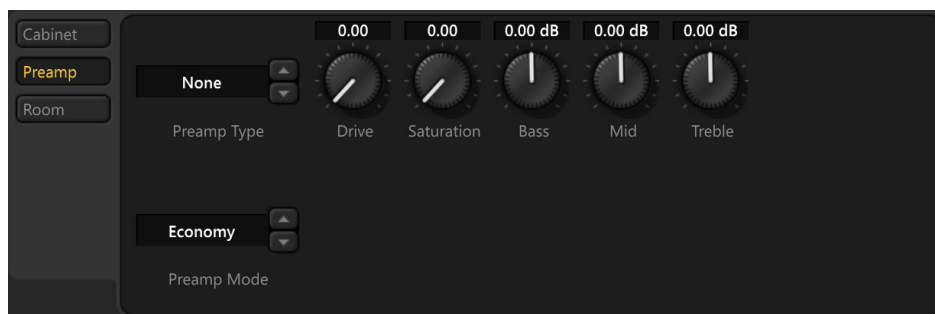

#### TOP ROW

**PREAMP TYPE** – Preamp simulation menu selections recreate the sound of overdriven channel strips, preamps, tapes, etc.

**DRIVE** – Controls the gain of the simulation.

**SATURATION** – Controls the ratio of even/odd harmonics. Turning the knob clockwise increases even harmonics.

#### BOTTOM ROW

**PREAMP MODE** – Selects either Economy or High Quality modes. In High Quality mode oversampling is employed to prevent aliasing but this results in higher CPU usage.

<sup>1</sup> Moves to the ADVANCED page when the cab block is set to stereo.





#### TOP ROW

**ROOM LEVEL/SIZE** – Determines the level and size of room reverb that is built into the cab block. Increase to add room ambience to the sound.

**MIC SPACING** – Increases delay times inside the room reverb by simulating the distance of the room microphone from the sound source.

**AIR** - Mixes some of the signal going into the Cab block with the signal leaving the Cab block.

**AIR FREQUENCY** – Sets the cutoff frequency of the mixed signal. Increase to maximum value for a straight mix.

#### BOTTOM ROW

Scott Peterson Tip – When using headphones (I use Audio Technica ATH-M50) use the Room controls in the cab block to simulate early reflections. It's a HUGE aspect usually missed with headphones.

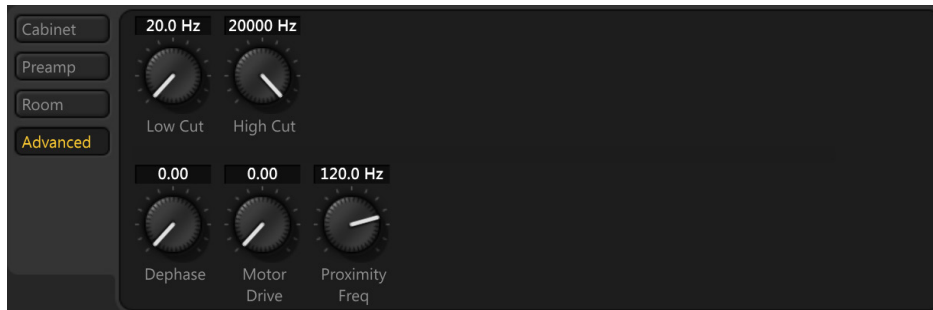

#### TOP ROW

**LOW/HIGH CUT** – Adjusts the cutoff point of first order low/high pass filters. Increase the Low Cut if the sound is too “bassy” or “boomy.” Decrease the High Cut for a darker cab tone. Common settings are 80-150 Hz for high pass, and 5-7 kHz for low pass.

**NOTE:** The Advanced page only appears when the cab block is set to stereo.

#### BOTTOM ROW

**DEPHASE** – controls a sophisticated process that removes the “phasiness” from IRs and can yield a more “in the room” experience. The higher the setting the more “character” you remove.

**MOTOR DRIVE** – Models the effect of high power levels on speaker tone. Simulates the impedance and distortion effects that occur when the speaker is pushed hard. Be aware this setting adds a little compression as you increase it.

**PROXIMITY FREQ** – This allows tuning the frequency range over which the proximity effect occurs.



#### EFFECT TYPE

**HI-/ULTRA-RES** – Mono processing of Hi Res IRs (2048 samples, 43ms), or UltraRes IRs (up to 8000 samples, 167ms).

**NORMAL RES** – Mono processing of normal resolution IRs (1024 samples, 21ms).

**STEREO ULTRARES** – Stereo processing of UltraRes IRs.

**STEREO** – Stereo processing at normal resolution (2 × 1024).

To calculate length: 1 millisecond = 48 samples.

**LINK (CABINET Page - STEREO ONLY)** – Sets the left channel parameters as master controls, which set identical values for left and right. You can still set right channel values independently.

UltraRes enhances the spectral resolution of an IR without adding CPU burden.

<u>AXE-FX AMP</u>	<u>BASED ON</u>	<u>DESCRIPTION</u>
1959SLP Jump	Marshall 1959SLP	reissue of a late 60's 100w Marshall Super Lead model 1959. See PLEXI 100W for the original. Emulates "jumpering the inputs" on a 4-hole amp.
1959SLP Normal	Marshall 1959SLP	Normal channel.
1959SLP Treble	Marshall 1959SLP	Treble channel.
1987X Jump	Marshall 1987x Vintage Series	Reissue of the 50w JMP Lead 1987. Features an "essential" mod to the tonestack of this Plexi. Emulates "jumpering the inputs" on a 4-hole amp.
1987X Normal	Marshall 1987x Vintage Series	Normal channel.
1987X Treble	Marshall 1987x Vintage Series	Treble channel.
5153 100w Blue	EVH 5150 III (Blue)	Blue (medium gain/rhythm) channel. 100w, 6L6. Made in collaboration with Fender. <a href="#">Recommended settings.</a>
5153 100w Green	EVH 5150 III (Green)	Green (clean) channel.
5153 100w Red	EVH 5150 III (Red)	Red (high gain/lead) channel.
5153 50w Blue	EVH 5150 III (Blue)	The 50w version has a different input network than the 100w, and as a result has about twice the gain.
59 Bassguy	Fender Bassman	1959, Tweed era, 5F6-A circuit. Low-to-medium gain amp designed for bass but widely adopted by guitarists.
5F1 Tweed	Fender Champ	5F1 circuit ('58-'64), single-ended, Class A, 5w. This particular amp exhibits a unique breakup characteristic due to its single-ended design and simple circuit.
5F8 Tweed	Fender Twin	1959 Fender Twin, Keith Urban's "#1".
65 Bassguy Bass	Fender Bassman	Bass channel.
65 Bassguy Nrm1	Fender Bassman	1965 Blackface version, AB165 circuit which is very crunchy and bright and does not sound like a typical Fender.
6G12 Concert	Fender Brownface Concert 6G12	1959-1963 4x10 brownface, 40w.
6G4 Super	Fender Brownface Super 6G4	1960-1963 2x10 brownface, 40w.
AC-20 12AX7 B	Morgan AC20 Deluxe	Bass channel, preamp tube switch in the 12AX7 position, EL84 tubes.
AC-20 12AX7 T	Morgan AC20 Deluxe	Treble channel, preamp tube switch in the 12AX7 position.
AC-20 EF86 B	Morgan AC20 Deluxe	Bass channel, preamp tube switch in the EF86 position.
AC-20 EF86 T	Morgan AC20 Deluxe	Treble channel, preamp tube switch in the EF86 position.
Angle Severe 1	ENGL Savage 120	Rough channel. Contour = OFF: boosts lower midrange around 500 Hz (warm tone.)
Angle Severe 2	ENGL Savage 120	Contour ON: boosts from 1200 Hz and cuts lower midrange (more transparency.)
Atomica High	Cameron Atomica	A "brown sound" 100w amp, high gain channel.
Atomica Low	Cameron Atomica	Low gain channel.
Band-Commander	Fender Bandmaster	1968 Silverface Fender Bandmaster with the AB763 circuit.
Big Hair	80's metal	Mids without mud. Revive the 80s metal scene. (Spandex not included.)
Blanknshp Leeds	Blankenship Leeds 21	EL84 tubes. Boutique version of an 18w Marshall with a big sound at low power. Mercury Magnetics transformers.
Bludojai Clean	Bludotone Ojai (Clean)	Reported to be an exact clone of Robben Ford's Tan Dumble. Clean mode modeled with preamp boost (PAB) engaged as the owner prefers this. To disengage PAB change the tonestack type to Skyline.
Bludojai Ld 1	Bludotone Ojai (Lead)	Lead mode, PAB = ON.
Bludojai Ld 2	Bludotone Ojai (Lead)	Lead mode, PAB = OFF.
Bogfish Brown	Bogner Fish preamp	Blue 4-channel tube preamp. Brown = fat high gain.
Bogfish Strato	Bogner Fish preamp	Strato = tight high gain.
Boutique 1	Matchless Chieftain	Medium-gain amp, thick, yet crisp, with a fair amount of power amp breakup. Based on a Vox circuit.
Boutique 2	Matchless Chieftain	Added Boost for more gain and high-frequency emphasis.
Brit 800	Marshall JCM800	Model 2204. Bring the Master up for true 80's tone. To soften the attack, lower Triode Freq and increase Neg Fdbk.
Brit 800 Mod	modded Marshall JCM800	Removed the treble peaker, making the amp "heavier" and "less strident".
Brit AFS100 1	Marshall AFD100SCE	#34/AFD switch set to #34 mode (LED = off), the equivalent of a JCM800 (2203). 6550 tubes.
Brit AFS100 2	Marshall AFD100SCE	#34/AFD switch set to AFD mode (LED = on), adds extra gain stage. 6550 tubes.

Red amps are non-MV (no Master Volume on the real amp). The MASTER VOLUME is set to 10 by default.

⚡ Includes the additional OVERDRIVE control.

🔊 The actual amp has a control labeled "Tone" which corresponds to TREB on the Axe-Fx. For a more realistic simulation, leave BASS and MID at noon.

⚡ Amps with NEGATIVE FEEDBACK set to zero. PRESENCE is replaced with HI CUT. DEPTH is also disabled since it only affects negative feedback.

<u>AXE-FX AMP</u>	<u>BASED ON</u>	<u>DESCRIPTION</u>
Brit Brown	Van Halen's Marshall.	Faithful recreation of the legendary "Brown Sound" – The modded "#1" Marshall.
Brit JM45	Marshall JTM45 (Ch 1)	Made famous by Clapton and others; a modified Bassman design. Try with a Tonebender or Treble Booster.
Brit JM45 Jump	Marshall JTM45 (Ch 1)	Emulates "jumping the inputs" on a 4-hole amp.
Brit JVM OD1 Gn	Marshall JVM410 (OD1, Green)	OD1 channel, Green mode, hot-rodded JCM.
Brit JVM OD1 Or	Marshall JVM410 (OD1, Orange)	OD1 channel, Orange mode, extra gain.
Brit JVM OD1 Rd	Marshall JVM410 (OD1, Red)	OD1 channel, Red mode, even more gain.
Brit JVM OD2 Gn	Marshall JVM410 (OD2, Green)	OD2 channel, Green mode, lower mids than OD1.
Brit JVM OD2 Or	Marshall JVM410 (OD2, Orange)	OD2 channel, Orange mode, more gain and lower mids than OD1.
Brit JVM OD2 Rd	Marshall JVM410 (OD2, Red)	OD2 channel, Red mode, even more gain and lower mids than OD1.
Brit Pre	Marshall JMP-1 preamp	Rack-mount preamplifier version of the Brit 800. OD2 channel. Crunchy "ZZ" tone.
Brit Silver	Marshall Silver Jubilee	100w Marshall Silver Jubilee (2555), commemorative "25/50" model. Slightly darker and higher gain than JCM800.
Brit Super	Marshall AFD100	100w dual-mode head with 6550 tubes, believed to be a modified 1959 Tremolo. Used by Slash on "Appetite for Destruction". Based on a schematic. See Brit AFS100 1 & 2 for updated models based on the actual amp.
Buttery	Budda Twinmaster	Based loosely on a late 90's specimen. Relies mostly on power amp distortion.
CA OD-2	Carol-Ann OD-2	50W, EL34 or 6L6 tubes. Overdrive channel. Model fine-tuned by the highly respected Alan Phillips.
CA Triptik Cln	Carol-Ann Triptik (Clean)	50w, EL34. Clean channel.
CA Triptik Clsc	Carol-Ann Triptik (Classic)	Classic channel: A little less gain and low end. Produces 70's and 80's British rock tones with a very wide and complex sound stage with no buzz or brittle high frequencies.
CA Triptik Mdrn	Carol-Ann Triptik (Modern)	Modern channel: More gain and low end for those more modern heavy rhythm, dropped tunings. Also makes for a superb liquid lead channel with incredible sustain and harmonic bloom.
CA Tucana Cln	Carol-Ann Tucana 3	Clean channel of this 3-channel amp, with Bias monitoring system, KT88 75W tubes.
CA Tucana Lead	Carol-Ann Tucana 3	Lead channel. This is a great lead amp which works well with many speaker/cab combinations. "One of the best amps in the world," says Cliff.
CA3+ Clean	CAE 3+ SE preamp (Ch 1)	Custom Audio Electronics preamp. The Clean channel is based on a Blackface Fender Twin Reverb preamp.
CA3+ Lead	CAE 3+ SE preamp (Ch 3)	Channel 3 (Lead). The CAE 3+ SE is basically an OD-100.
CA3+ Rhy	CAE 3+ SE preamp (Ch 2)	Channel 2 (Rhythm).
Cali Leggy	Carvin Legacy VL100	Legacy 1, 100w, EL34. Uses a "James" tone stack which is more like hi-fi tone controls. Based on Steve Vai's original signature Legacy amplifier. To get a Steve Vai tone, keep Treble low, Bass high and not too much Gain.
Cameron CCV 1A	Cameron CCV100 (Ch 1)	An amp its creator Mark Cameron calls "one pissed off amp." The topology is very similar to a JCM800. Both channels modeled at various settings. The amp was modeled with the Voicing switch in the middle position. The "Dark" switch is the Negative feedback control. Set Negative Feedback to 3.6 to reproduce the switch in the middle position. Set it to 9.8 to reproduce the switch in the right position. 5.0 for left position (default).
Cameron CCV 1B	Cameron CCV100 (Ch 1)	
Cameron CCV 2A	Cameron CCV100 (Ch 2)	Ch 2 has Saturation engaged by default. Bright1 switch selects the Bright capacitor, which can be altered with the BRIGHT CAP setting on the Tone page. This model: Bright1 switch left, Bright2 switch left, Gain Style switch left.
Cameron CCV 2B	Cameron CCV100 (Ch 2)	Bright1 switch left, Bright2 switch right, Gain Style switch left.
Cameron CCV 2C	Cameron CCV100 (Ch 2)	Bright1 switch left, Bright2 switch left, Gain Style switch right.
Cameron CCV 2D	Cameron CCV100 (Ch 2)	Bright1 switch left, Bright2 switch right, Gain Style switch right.
Car Roamer	Carr Rambler	Basically a Deluxe Reverb preamp with cathode bias 6L6 power amp and no negative feedback. Fender-meets-Vox. On the actual amp, a toggle switch engages either the 28w pentode or 14w triode.
Citrus A30 Cln	Orange AD30HTC (Clean)	30w tube head, Clean channel.
Citrus A30 Drty	Orange AD30HTC (Dirty)	30w tube head, Dirty channel.
Citrus Bass 200	Orange AD200B	200w valve bass head, 6550 tubes.

Red amps are non-MV (no Master Volume on the real amp). The MASTER VOLUME is set to 10 by default.

⊕ Includes the additional OVERDRIVE control.

⊗ The actual amp has a control labeled "Tone" which corresponds to TREB on the Axe-Fx. For a more realistic simulation, leave BASS and MID at noon.

⊗ Amps with NEGATIVE FEEDBACK set to zero. PRESENCE is replaced with HI CUT. DEPTH is also disabled since it only affects negative feedback.







<u>AXE-FX AMP</u>	<u>BASED ON</u>	<u>DESCRIPTION</u>
Citrus RV50	Orange Rockerverb	"Dirty" channel of the 50w head known for warmth and rich harmonics.
Citrus Terrier ☼	Orange Tiny Terror	7w or 15w, EL84 tubes. The actual amp has no tone stack (neutral in Axe-Fx) and a single Hi-Cut tone control.
Class-A 15w TB ☼	Vox AC-15 Top Boost	15w, EL84 tubes. The heart of this amp's tone comes from its power section and no negative feedback.
Class-A 30w ☼	Vox AC-30	30w, EL84 tubes. Combo that dominated the British Invasion. Gritty character, warm tone, great feel. For authentic tone, leave the tone controls at noon and use Hi-Cut to cut treble.
Class-A 30w BRT ☼	Vox AC-30 (Bright)	Bright channel of a non-Top Boost Vox AC30.
Class-A 30w Hot ☼	Vox AC-30 HW	30w, EL84 tubes. Hot/Cool switch set to Hot position, which bypasses the tone circuitry to create a more pure sound to achieve richer gain.
Class-A 30w TB ☼	Vox AC-30 Top Boost	30w, EL84 tubes. Created in response to demand for "more treble". Great highs and slightly reduced bass. Hot/Cool switch set to Cool position, which produces the orthodox Top Boost sound.
Comet 60	Komet 60	EL34 tubes.
Comet Concourse	Komet Concorde	EL34 tubes. Similar to Trainwreck amp. Response switch = "Fast". To replicate "Slow" reduce INPUT TRIM to 0.25".
Corncob M50 †	Cornford MK50 II	Boutique British amp. Plexi-meets-modern tone with big cojones.
Das Metall	Diezel VH4 (Ch 4)	EL34 or 6L6 tubes. High-gain, boutique amp famous for its powerful, heavy, aggressive sound. See <i>Dizzy V4 4</i> .
Deluxe Tweed ☼ ☼	Fender Tweed Deluxe	Fender Deluxe (5E3) from the 50's, 15w. The earliest and most popular of the so-called Tweed amplifiers. "60's hippie rock in a bottle," says Cliff.
Deluxe Verb Nrm	Fender Deluxe Reverb (Normal)	1965 Blackface, 22w, AB763 circuit. Great, chimey tone with nice power amp breakup.
Deluxe Verb Vib	Fender Deluxe Reverb (Vibrato)	Vibrato channel.
Dirty Shirley	Friedman Dirty Shirley	40w, 6L6. Designed to be an ultra-fat, sweet-sounding, classic rock amp. Based on a JTM45.
Div/13 CJ ☼	Divided by 13 CJ 11	11w, bassy amp, works best with single coils. High-performing "Tweed" meets "EL34" meets "Master Vol" 1x12.
Div/13 CJ Boost ☼	Divided by 13 CJ 11	Volume knob pulled out (boost switch).
Div/13 FT37 Hi ☼	Divided by 13 FTR 37	Divided by 13 FTR 37, 37w, Class-AB, two channels, 6V6 tubes. Gain Boost ON.
Div/13 FT37 Lo ☼	Divided by 13 FTR 37	Gain Boost OFF.
Dizzy V4 Blue 2	Diezel VH4 (Ch 2)	High-gain boutique amp with heavy, aggressive sound. 6550, EL34 or 6L6. Channel 2, "gritty funk, dynamic clean"
Dizzy V4 Blue 3	Diezel VH4 (Ch 3)	Channel 3, the favorite channel for most users, with higher gain but still big dynamic range.
Dizzy V4 Blue 4	Diezel VH4 (Ch 4)	Channel 4, newer version of <i>Das Metall</i> . A monster of gain which still has great definition and authority.
Dizzy V4 Slvr 2	Diezel VH4 (Ch 2)	Silver-faced version of the Diezel VH4.
Dizzy V4 Slvr 3	Diezel VH4 (Ch 3)	Silver-faced version of the Diezel VH4.
Dizzy V4 Slvr 4	Diezel VH4 (Ch 4)	Silver-faced version of the Diezel VH4.
Double Verb Nrm	Fender Twin Reverb (Normal)	100w, 1966 Blackface, AB763 circuit. Known for amazing clean sounds and nice breakup.
Double Verb SF	Fender Twin Reverb (Vibrato)	Vibrato channel of a 1971 Silverface.
Double Verb Vib	Fender Twin Reverb (Vibrato)	Vibrato channel of a 1966 Blackface.
Dweezil's B-Man	Fender Bassman	Blankenship-modified 1965 Blackface with AB165 circuit (CBS era), Bass channel, 6L6 tubes, 50 watt. Yek: It has a boatload of gain and sounds more like a Plexi than a Fender.
Energyball	ENGL Powerball	100w Lead channel, 6L6 tubes. Very high-gain German model. Lots of bass. Great for aggressive, drop-tuned riffs.
Euro Blue	Bogner Ecstasy (Blue)	20th Anniv. model. Dark amp, turn up Presence or engage Bright. Blue channel, Structure switch = 'V' (Vintage).
Euro Blue Mdrn	Bogner Ecstasy (Blue)	Blue channel, Structure switch = 'M' (Modern).
Euro Red	Bogner Ecstasy (Red)	Red channel, Structure switch = 'V' (Vintage).
Euro Red Mdrn	Bogner Ecstasy (Red)	Red channel, Structure switch = 'M' (Modern).
Euro Uber	Bogner Überschall	120w, EL34. High Gain channel. Heavy grinding lows and insane gain. Sweep Presence for a wide variety of tones.
FAS 6160	Peavey EVH 5150	Alternative version of the PVH 6160, more open and less fizzy than the original amp. Also, a virtual choke has replaced the resistor found on the original's power supply filter. This results in a bouncier feel.
FAS Bass	n/a	Custom Fractal bass model. This amp uses an active tone stack so the Fat switch will have no effect.

Red amps are non-MV (no Master Volume on the real amp). The MASTER VOLUME is set to 10 by default.

† Includes the additional OVERDRIVE control.

☼ The actual amp has a control labeled "Tone" which corresponds to TREB on the Axe-Fx. For a more realistic simulation, leave BASS and MID at noon.

☼ Amps with NEGATIVE FEEDBACK set to zero. PRESENCE is replaced with HI CUT. DEPTH is also disabled since it only affects negative feedback.

<u>AXE-FX AMP</u>	<u>BASED ON</u>	<u>DESCRIPTION</u>
FAS Brootalz	ENGL Savage 120 / SLO 100	ENGL Savage model with the input stage (and possibly power amp) from an SLO100.
FAS Brown	Van Halen's Marshall	Original BROWN model from the Axe-Fx Standard/Ultra.
FAS Class-A 	Carr Rambler	A "Blackface" preamp into a cathode-biased 6L6 power amp with no negative feedback. This was a happy accident when originally modeling the Carr Rambler in the beta version of firmware v12.03.
FAS Crunch	ultimate British amp	More dynamic and open than a Plexi, but with more gain.
FAS Hot Rod	modded Marshall	From Cliff: the FAS Hot Rod is my version of what a modded Marshall should be. I find the BE/HBE a little too boomy and scooped. Bogners are too dark. Splawns don't have enough compression, etc.
FAS Lead 1	Mesa Boogie TriAxis (presumed)	Neutral high-gain lead with a tight midrange.
FAS Lead 2	Mesa Boogie TriAxis (presumed)	Hot-rodded British lead sound with a tonestack by Bob Bradshaw (Custom Audio Electronics).
FAS Modern	high gain rhythm + lead hybrid	High-gain hybrid. Equally well-suited to modern rhythm or lead work. Loosely based on a Recto with tighter bass.
FAS Modern II	high gain rhythm + lead hybrid	Tighter version of the popular FAS Modern model with a 5150-style bass boost in the tone stack.
FAS Modern III	high gain rhythm + lead hybrid	Similar to a Recto, but with tighter bass and a cathode-based power amp.
FAS Rhythm	British + USA crunch	Combines the best features of the British and USA crunch models.
FAS Wreck	Trainwreck Express	Original WRECKER 1 model from the Axe-Fx Ultra.
Fox ODS 	Fuchs Overdrive Supreme-50	Dumble clone. Overdrive channel, 50w, 6L6 tubes. Preamp Bypass (PAB) active.
Fox ODS Deep 	Fuchs Overdrive Supreme-50	Deep switch ON.
Friedman BE	Friedman Brown Eye	50w or 100w, EL34. What many call "the ultimate modded Plexi" by Dave Friedman (Rack Systems). Non-"V" model based on the older "Marsha" model, which is darker and more bassy than the "V" models.
Friedman BE V1	Friedman Brown Eye	Based on Mark Day's BE100 amp. Voice switch toggled right (brighter, more bass).
Friedman BE V2	Friedman Brown Eye	Based on Mark Day's BE100 amp. Voice switch toggled left (darker, more mids).
Friedman HBE	Friedman Hairy Brown Eye	BE amp's alternate voicing with a gain boost. Non-"V" model based on the older "Marsha" model.
Friedman HBE V1	Friedman Hairy Brown Eye	Based on Mark Day's BE100 amp. Voice switch toggled right (brighter, more bass).
Friedman HBE V2	Friedman Hairy Brown Eye	Based on Mark Day's BE100 amp. Voice switch toggled left (darker, more mids).
Friedman Sm Box	Friedman Small Box (Ch 2)	50W, EL34. Channel 2 is the modern/high gain channel.
Fryette D60 L 	Fryette D60 (Less)	60w, KT88 or 6550 tubes. "Deliverance Sixty". "Less" mode.
Fryette D60 M 	Fryette D60 (More)	"More" mode.
Gibtone Scout 	Gibson Scout	1964 GA17RVT Scout, 17w, vintage clean tones. No tone controls on the real amp.
Herbie Ch2+	Diezel Herbert (Ch 2+)	3-channel 180w, called "looser" and "more "familiar" than the VH4. Channel 2+ gets you into Diezel VH4 territory.
Herbie Ch2-	Diezel Herbert (Ch 2-)	Set Ch 2- at 35% gain for a cranked Plexi tone, 60% for a JCM800 tone.
Herbie Ch3	Diezel Herbert (Ch 3)	Channel 3.
Hipower Brillnt.	Hiwatt DR103 (Brilliant)	1974 Harry Joyce/Hylight model. Medium-gain, full sound with unique tone-stack and chimey, grinding tone.
Hipower Jumped	Hiwatt DR103 (Normal/Brilliant)	Emulates "jumpering the inputs" on a 4-hole amp.
Hipower Normal	Hiwatt DR103 (Normal)	Normal channel.
Hot Kitty 	Bad Cat Hot Cat 30r (Ch 2)	30w, EL34, cathode bias, Channel 2. Voted by Guitar Player as "the second best combo of all time"
Jazz 120	Roland JC-120	120w (stereo: 2x 60w). The only solid-state-based model in the collection, a quintessential clean tone.
JMPre-1 OD1	Marshall JMP-1 preamp	Rack-mount preamplifier version of the Brit 800. OD1 channel.
JMPre-1 OD1 BS	Marshall JMP-1 preamp	Bass Shift = ON
JMPre-1 OD2	Marshall JMP-1 preamp	Rack-mount preamplifier version of the Brit 800. OD2 channel. Crunchy "ZZ" tone. Also see Brit Pre.
JMPre-1 OD2 BS	Marshall JMP-1 preamp	Bass Shift = ON
JR Blues	Fender Blues Jr.	15w. A gutsy little classic with dual EL84s. To get the tone of an Egnater Rebel 20, set the Neg Fdbk to zero.
JR Blues Fat	Fender Blues Jr.	FAT switch engaged.
JS410 Crunch Or	Marshall JVM410HJS	Joe Satriani's 4-channel 100w signature amp. EL34 tubes. Joe said he puts all the tone controls at around 10:00. Crunch Or: based on a JCM 2203.

Red amps are non-MV (no Master Volume on the real amp). The MASTER VOLUME is set to 10 by default.

 Includes the additional OVERDRIVE control.

 The actual amp has a control labeled "Tone" which corresponds to TREB on the Axe-Fx. For a more realistic simulation, leave BASS and MID at noon.

 Amps with NEGATIVE FEEDBACK set to zero. PRESENCE is replaced with HI CUT. DEPTH is also disabled since it only affects negative feedback.

<u>AXE-FX AMP</u>	<u>BASED ON</u>	<u>DESCRIPTION</u>
JS410 Crunch Rd	Marshall JVM410HJS	Crunch Rd: based on a modded JCM 2203.
JS410 Lead Or	Marshall JVM410HJS	Lead Or: more gain.
JS410 Lead Rd	Marshall JVM410HJS	Lead Rd: even more gain.
Matchbox D-30 ☞	Matchless DC-30	Matchless DC-30, 30w, Class-A, EL84s. A "better sounding" AC-30.
Mr Z Hwy 66	Dr. Z Route 66	32w, KT66, EF86 and 12AX7.
Mr Z MZ-38 ☞	Dr. Z MAZ 38 SR	38w, EL84 tubes. Popular with country and roots players. The quintessential country amp.
Mr Z MZ-8 ☞	Dr. Z MAZ 8	8w, EL84 tube. A popular low-wattage, single-ended amp. The actual amp can be run in Pentode or Triode mode.
Nuclear-Tone ☞☞	Swart Atomic Space Tone	20w, 6V6. As with the actual amp, the bias tremolo is particularly effective.
ODS-100 Clean	Dumble OD Special (Clean)	100w "HRM" (Hot Rod Marshall) version, Clean channel. A coveted but rare amp made famous by Robben Ford.
ODS-100 Ford 1 †	Dumble OD Special (OD)	"Non-HRM" version. Preamp Bypass ON. The default tone stack is neutral (with B/M/T at noon the response is flat.)
ODS-100 Ford 2 †	Dumble OD Special (OD)	"Non-HRM" version. Preamp Bypass OFF.
ODS-100 Ford Md †	Dumble OD Special (OD)	The same as ODS-100 Ford 1 with the Mid switch engaged.
ODS-100 HRM †	Dumble OD Special (OD)	Lead channel matched with the preamp bypass (PAB) engaged (which bypasses the input tone stack) and the Drive control at approximately 7.0. Played by the great Larry Carlton and many others!
ODS-100 HRM Mid †	Dumble OD Special (OD)	Lead channel with the "Mid" switch engaged (this switch is sometimes labeled "Deep").
Plexi 100w 1970	Marshall Super Lead 1959	1970 model. This particular amp has a darker, smoother sound than earlier Plexis. Cliff: "use with Factory Cab #54. Be sure to dial it in like you would in 1970, i.e. turn the Mid, Treble and Presence way up; turn Norm Drive and Bass down a bit.
Plexi 100w High	Marshall Super Lead 1959	1968 model. Classic amp head that gave rise to "the stack." Great for crunchy rhythm work. As with the real amp, don't be afraid to turn the bass all the way down or the treble all the way up, or it's too flubby. Treble channel.
Plexi 100w Jump	Marshall Super Lead 1959	Emulates "jumpering the inputs" on a 4-hole amp.
Plexi 100w Nrml	Marshall Super Lead 1959	Normal channel.
Plexi 50w 6550	Marshall Super Lead 1959	High input of a 1972 50w Marshall "Plexi" with 6550 power tubes.
Plexi 50w Hi 1	Marshall Super Lead 1959	1972 model. Treble channel.
Plexi 50w Hi 2	Marshall Super Lead 1959	The second triode stage has a 0.68uF cathode bypass capacitor. The second bypass capacitor was added in the early 70's and gives a slightly brighter tone.
Plexi 50w Jump	Marshall Super Lead 1959	Emulates "jumpering the inputs" on a 4-hole amp.
Plexi 50w Nrml	Marshall Super Lead 1959	Normal channel.
Prince Tone ☞	Fender Princeton (Tweed)	Class A, 5w. 5F2-A, AA964 circuits. Modeled after early CBS "Silverface" model, pre-CBS design and components.
Prince Tone NR ☞	Fender Princeton (no reverb)	No reverb.
Prince Tone Rev ☞	Fender Princeton (reverb)	1966 reverb.
PVH 6160 Block	Peavey EVH 5150 (Lead)	120w, 6L6. An original block letter Peavey EVH 5150. Lead channel. It sounds way better than most 5150s partly due to the fact that this one has a bias mod so it's biased a bit warmer than a stock version.
PVH 6160+ Ld	Peavey 6505+	120w, 6L6. Identical to the EVH II.
PVH 6160+ Rhy	Peavey 6505+	Channel 1 with the Crunch switch depressed and Bright switch out.
PVH 6160+ Rhy B	Peavey 6505+	Channel 1 with the Crunch and Bright switches depressed.
Recto1 Org Mdrn ☞	Mesa Boogie 2 ch. Dual Rectifier	Orange channel, Modern mode. Presence control now operates like the actual amp in all Recto models. <i>For those models where there is no negative feedback, the Presence control is part of the tone stack (not a Hi Cut control).</i>
Recto1 Org Norm	Mesa Boogie 2 ch. Dual Rectifier	Orange channel, Normal mode. Warmer and less fizzy than the 3 channel model.
Recto1 Red Mdrn ☞	Mesa Boogie 2 ch. Dual Rectifier	Red channel, Modern mode.
Recto2 Org Mdrn ☞	Mesa Boogie 3 ch. Dual Rectifier	Orange channel, Modern mode.
Recto2 Org Vntg	Mesa Boogie 3 ch. Dual Rectifier	Orange channel, Vintage mode.
Recto2 Red Mdrn ☞	Mesa Boogie 3 ch. Dual Rectifier	Red channel, Modern mode.

Red amps are non-MV (no Master Volume on the real amp). The MASTER VOLUME is set to 10 by default.

† Includes the additional OVERDRIVE control.

☞ The actual amp has a control labeled "Tone" which corresponds to TREB on the Axe-Fx. For a more realistic simulation, leave BASS and MID at noon.

☞ Amps with NEGATIVE FEEDBACK set to zero. PRESENCE is replaced with HI CUT. DEPTH is also disabled since it only affects negative feedback.

<u>AXE-FX AMP</u>	<u>BASED ON</u>	<u>DESCRIPTION</u>
Recto2 Red Vntg . . . . .	Mesa Boogie 3 ch. Dual Rectifier . . .	Red channel , Vintage mode.
Ruby Rocket 🎸 . . . . .	Paul Ruby Rocket . . . . .	Paul Ruby Rocket is based on a Trainwreck Rocket but with some notable differences (also similar to a Vox AC30). Bright switch in the down position.
Ruby Rocket Brt 🎸 . . . . .	Paul Ruby Rocket . . . . .	Bright switch in the up position.
Shiver Cln. . . . .	Bogner Shiva (Clean) . . . . .	90w, KT88. 20th anniv. Clean channel, powerful shimmering cleans. Dark amp, turn up Presence or engage Bright.
Shiver Ld . . . . .	Bogner Shiva (Lead) . . . . .	Lead channel, sweet, rich-sounding amp with aggressive, English-style midrange punch.
Solo 100 Clean . . . . .	Soldano SLO-100 (Nrml/Clean) . . . . .	SLO = Super Lead Overdrive, 100w. Normal channel, Clean gain selector.
Solo 100 Lead . . . . .	Soldano SLO-100 (Lead) . . . . .	Snarling Lead channel. This amp likes to be run hard, so the MV defaults to a higher setting than on most other amps (high MV helps thicken up the mids). To achieve the best sound, also back off the preamp gain.
Solo 100 Rhy . . . . .	Soldano SLO-100 (Nrml/Crunch) . . . . .	Normal channel, Crunch gain selector. Aggressive rhythm.
Solo 88 Clean . . . . .	Soldano X88R preamp (Clean) . . . . .	Clean channel of a Soldano X88R preamp, 6L6
Solo 88 Lead . . . . .	Soldano X88R preamp (Lead) . . . . .	Lead channel.
Solo 88 Rhythm . . . . .	Soldano X88R preamp (Rhythm) . . . . .	Rhythm channel.
Solo 99 Clean . . . . .	Soldano X99 preamp (Clean) . . . . .	Clean channel of a Soldano/Caswell midi-motorized X99 preamp.
Solo 99 Lead . . . . .	Soldano X99 preamp (Lead) . . . . .	Lead channel.
Spawn Nitrous 1 . . . . .	Splawn Nitro (OD) . . . . .	100w, KT-88, OD-1 mode. Splawn tone with more saturation and voiced for a bigger low end and low mids.
Spawn Nitrous 2 . . . . .	Splawn Nitro (OD) . . . . .	100w, KT-88, OD-2 mode.
Spawn Rod OD1-1 . . . . .	Splawn Quick Rod (1st gear) . . . . .	100w, EL34. Signature Splawn tone with lots of bite, strong mids and 3 gear versatility. 1st gear, "Hot Rod Plexi".
Spawn Rod OD1-2 . . . . .	Splawn Quick Rod (2nd gear) . . . . .	2nd gear, "Hot Rod JCM 800".
Spawn Rod OD1-3 . . . . .	Splawn Quick Rod (3rd gear) . . . . .	3rd gear, "Super Hot Rod 800".
Spawn Rod OD2-1 . . . . .	Splawn Quick Rod (1st gear) . . . . .	1st gear; OD2 switches in a cathode bypass cap which increases the gain of that stage.
Spawn Rod OD2-2 . . . . .	Splawn Quick Rod (2nd gear) . . . . .	2nd gear; same as above.
Spawn Rod OD2-3 . . . . .	Splawn Quick Rod (3rd gear) . . . . .	3rd gear; same as above.
Suhr Badger 18 🎸 . . . . .	Suhr Badger 18w . . . . .	18w version of this EL84-powered tube rectifier classic. Master Volume is VERY powerful at altering the tone.
Suhr Badger 30 🎸 . . . . .	Suhr Badger 30w . . . . .	In comparison to the 18w, the 30w features a solid state rectifier.
Super Verb Nrm . . . . .	Fender Super Reverb (Normal) . . . . .	Pre-CBS 1964 Blackface version of this 40w amp, AB763 circuit, Vibrato channel. To simulate the Blackface Pro Reverb model AA165, set Tonestack Type = Blackface and set Mid = 7-8 to emulate the fixed 6.8K mid resistor.
Super Verb Vib . . . . .	Fender Super Reverb (Vibrato) . . . . .	Vibrato channel.
Supertweed . . . . .	Fender Tweed series . . . . .	Original SUPERTWEED model from the Axe-Fx Ultra. "Like a vintage Tweed amplifier on steroids."
Supremo Trem 🎸 🎸 . . . . .	Supro 1964T . . . . .	Supro 1964T.
SV Bass . . . . .	Ampeg SVT . . . . .	300w, Super Vacuum Tube bass amp. Used for decades by famous bassists the world over.
Thordendal Mdrn 🎸 . . . . .	Mesa Boogie Dual Rectifier . . . . .	Based on the pre-G3 Recto models.
Thordendal Vint. . . . .	Mesa Boogie Dual Rectifier . . . . .	Based on the pre-G3 Recto models.
Tremolo Lux . . . . .	Fender AA763 Tremolux . . . . .	6L6, high and low inputs, Normal and Vibrato channels.
Tube Pre 🎸 . . . . .	generic tube preamp . . . . .	Completely neutral, low-gain tube preamp useful for "warming up" various sources.
Two Stone J35 1 🎸 . . . . .	Two-Rock Jet 35 . . . . .	35w, 6L6. Lead mode, Preamp Bypass ON, which bypasses the input tone stack for a more focused lead sound.
Two Stone J35 2 🎸 . . . . .	Two-Rock Jet 35 . . . . .	Lead mode, Preamp Bypass OFF.
TX Star Clean . . . . .	Mesa Lone Star (Clean) . . . . .	Clean channel, 50/100w, 6L6. Try with a BB Pre drive block.
TX Star Lead 🎸 . . . . .	Mesa Lone Star (Lead) . . . . .	Lead channel.
USA Bass 400 1 . . . . .	Mesa Bass 400 . . . . .	Bass Shift OFF.
USA Bass 400 2 . . . . .	Mesa Bass 400 . . . . .	Bass Shift ON.
USA Clean . . . . .	Mesa Boogie Mark IV (Rhy 1) . . . . .	Somewhat neutral, clean-sounding model that can pushed into warm clipping. Rhythm 1 channel.
USA IIC+ 🎸 . . . . .	Mesa Boogie Mark IIC+ (Lead) . . . . .	Famous for its smooth overdrive sound. Pull Bright OFF, Pull Deep OFF. Pull Bright on the amp's

Red amps are non-MV (no Master Volume on the real amp). The MASTER VOLUME is set to 10 by default.

🎸 Includes the additional OVERDRIVE control.

🎸 The actual amp has a control labeled "Tone" which corresponds to TREB on the Axe-Fx. For a more realistic simulation, leave BASS and MID at noon.

🎸 Amps with NEGATIVE FEEDBACK set to zero. PRESENCE is replaced with HI CUT. DEPTH is also disabled since it only affects negative feedback.

<u>AXE-FX AMP</u>	<u>BASED ON</u>	<u>DESCRIPTION</u>
		Volume knob = Axe-Fx Bright Switch; Pull Shift on the amp's Treble knob = Axe-Fx Fat switch.
USA IIC+ Bright †	Mesa Boogie Mark IIC+ (Lead)	Pull Bright ON, Pull Deep OFF.
USA IIC+ Brt/Dp †	Mesa Boogie Mark IIC+ (Lead)	Pull Bright ON, Pull Deep ON. The favorite IIC+. When dialing in the tone, start with the MV around 4.
USA IIC+ Deep †	Mesa Boogie Mark IIC+ (Lead)	Pull Bright OFF, Pull Deep ON.
USA IIC++ †	Mesa Boogie Mark IIC++	Metallica's amp.
USA Lead †	Mesa Boogie Mark IV (Lead)	Tight, focused, hi-gain sound. Great for fusion and rock leads. Bright OFF, Mid Gain OFF.
USA Lead + †	Mesa Boogie Mark IV (Lead)	Bright OFF, Mid Gain ON.
USA Lead Brt †	Mesa Boogie Mark IV (Lead)	Bright ON, Mid Gain OFF.
USA Lead Brt + †	Mesa Boogie Mark IV (Lead)	Bright ON, Mid Gain ON.
USA Pre Clean	Mesa Boogie TriAxis preamp	Rhythm Green channel ("Vintage Fat Rhythm" or "old Black Face"), 6L6.
USA Pre Ld1 Red †	Mesa Boogie TriAxis preamp	Lead 1 Red mode (TX-4 board.)
USA Pre Ld2 Grn †	Mesa Boogie TriAxis preamp	Lead 2 Green mode (Mid Gain Mark IV Lead.)
USA Pre Ld2 Red †	Mesa Boogie TriAxis preamp	Lead 2 Red mode (shred.)
USA Pre Ld2 Ylw †	Mesa Boogie TriAxis preamp	Lead 2 Yellow mode (Classic MKII Lead.)
USA Rhythm	Mesa Boogie Mark IV (Rhy 2)	THE California crunch rhythm sound. Rhythm Channel 2 with Fat switch OFF.
USA Sub Blues	Mesa Subway Blues	20w, EL84.
Vibra-King ⌘	Fender Vibro-King	Fender Vibro-King, famous for crystal cleans and powerful overdrive.
Vibra-King Fat ⌘	Fender Vibro-King	Fat switch ON.
Vibrato Lux	Fender Vibrolux Reverb	1963 Blackface model, 6L6. Early Dire Straits tone.
Vibrato Verb	Fender Vibroverb	40w combo that's great for clear or grinding cleans and gutsy blues. 6G16 circuit, Brownface era.
Vibrato Verb AA	Fender Vibroverb	AA763 circuit.
Vibrato Verb AB	Fender Vibroverb	AB763 circuit.
Vibrato Verb CS	Fender Vibroverb	Vibroverb Custom Reissue with the Mod switch ON. To replicate SRV's use of a Bassman transformer, increase Xfrmr Match to around 1.8
Wrecker Express	Trainwreck Express	Trainwreck Express.
Wrecker Lvrpool	Trainwreck Liverpool	Trainwreck Express preamp with a Trainwreck Rocket power amp. EL84 tubes.
Wrecker Rocket	Trainwreck Rocket	Trainwreck Rocket.

Red amps are non-MV (no Master Volume on the real amp). The MASTER VOLUME is set to 10 by default.

† Includes the additional OVERDRIVE control.

⊗ The actual amp has a control labeled "Tone" which corresponds to TREB on the Axe-Fx. For a more realistic simulation, leave BASS and MID at noon.

⌘ Amps with NEGATIVE FEEDBACK set to zero. PRESENCE is replaced with HI CUT. DEPTH is also disabled since it only affects negative feedback.



FACTORY CABINETS

1	1x6 Oval	46	4x12 Solo S12X (RW)	91	2x12 Double Verb Mix	135	1x12 AC-20 Dlx M160
2	1x8 Tweed	47	4x12 German V30 (RW)	92	2x12 Pro Verb Mix	136	1x12 Roamer R121 Reverse
3	1x10 Prince Tone AT4047	48	4x12 German Boutique	93	2x12 Class-A 30w Blue Mix	137	2x12 Double Verb M160
4	1x10 Prince Tone M160	49	4x12 PVH6160 (RW)	94	2x12 Class-A 30w Silver Mix	138	2x12 Class-A Blues Mix
5	1x12 Brown M160	50	4x12 Uber T75 (RW)	95	2x12 Supremo Mix	139	4x12 USA Lead 80S R121
6	1x12 Black SM57	51	4x12 Uber V30 (RW)	96	2x12 Santiago EJ1250	140	1x12 Dlx Aln-Slv Mix (OH)
7	1x12 G12T R121	52	4x12 Uber T75+V30 (RW)	97	2x12 Santiago Altec	141	1x12 Dlx Fn-42 Mix (OH)
8	1x12 E12L (RW)	53	4x12 Citrus V30 (RW)	98	3x10 Vibrato King Mix	142	1x12 Dlx J12-Pr Mix (OH)
9	1x12 Studio	54	4x12 Pre-Rola 55 M160 (ML)	99	4x10 Bassguy Mix	143	2x12 Bog-Sh Fn-42 Mix (OH)
10	1x12 EMI Open Back (JM)	55	4x12 Pre-Rola 75 M160 (ML)	100	4x10 Super Verb Mix	144	4x12 Mar-Cb EV-S Mix (OH)
11	1x12 Bludo Mix	56	4x12 Brit 80S R121 (ML)	101	4x12 Basketweave Green Mix	145	4x12 Mar-Cb Fn-42 Mix (OH)
12	1x12 Shiver 121 (BG)	57	4x12 SLM H75 (OH)	102	4x12 Basketweave AX Mix	146	4x12 Mar-Cb H-Pr-55 Mix (OH)
13	1x12 Tweed Blue (RW)	58	4x12 TV Mix C1 (ML)	103	4x12 Basketweave TV Mix	147	4x12 Mar-Cb M-BB-55 Mix (OH)
14	1x12 Tweed Deluxe (RW)	59	4x12 TV Mix C4 (ML)	104	4x12 Cali Lead 80s Mix	148	4x12 Mar-Cb Sb-75 Mix (OH)
15	1x12 Brit Blue (RW)	60	4x12 Fractal Gb M160	105	4x12 Rumble EV12L RNR1	149	4x12 Mar-Cb V30-Ch Mix (OH)
16	1x12 Brit G12H30 (RW)	61	4x12 Fractal V30 AT4047	106	4x12 Rumble EV12S M160	150	1x12 Shadow Mix (TAF)
17	1x15 Blues	62	4x12 V30	107	4x12 PVH6160 Mix	151	1x12 Vintage Mars Mix (TAF)
18	1x15 Thunderbolt (RW)	63	4x12 German	108	4x12 Petrucci V30 Mix	152	2x10 Fen Room Mix (TAF)
19	2x12 TX Star M160	64	4x12 30w (Ultra)	109	1x15 SV Bass M88 Mix	153	2x12 Art+Tango Jr Mix (TAF)
20	2x12 Double Amp KSM313	65	4x12 Cali	110	1x15 SV Bass Subkick Mix	154	2x12 Acrox Mix (TAF)
21	2x12 Double Verb R121	66	1x15 L.A. Bass	111	4x10 SV Bass M88 Mix	155	4x12 Wat Mix (TAF)
22	2x12 Brown Super M160	67	4x10 Aluminum Bass (RW)	112	4x10 SV Bass Subkick Mix	156	4x12 Starfound Mix (TAF)
23	2x12 Blue	68	8x10 SV Bass (RW)	113	4x10+Tweeter SV Bass M88 Mix	157	4x12 Mars G12T Room Mix (TAF)
24	2x12 Top Boost Blue (RW)	69	4x12 Pre-Rola Gb C414	114	1x12 AC-20 Dlx Mix	158	4x12 Mars Bw G12 Room Mix (TAF)
25	2x12 Top Boost Silver (RW)	70	4x12 Beatle Gb	115	1x12 Nuclear Tone Mix	159	4x12 Vintmars+Bw Room Mix (TAF)
26	2x12 Boutique (RW)	71	4x12 D120	116	1x12 Scumtone 25W Mix	160	4x12 5153 121 G
27	2x12 Fuzzbomb M160	72	4x12 Sorcerer	117	2x12 Boutique Mix	161	4x12 5153 4047 G
28	2x12 Gold 30 Far-Field (JM)	73	4x12 USA Trad 57-121 (ML)	118	2x12 SV Legend Mix	162	4x12 5153 57 C
29	2x12 G12-65 Far-Field (JM)	74	4x12 USA Trad 906-421 (ML)	119	1x12 AC-20 Dlx Mix	163	4x12 Citrus 121 B
30	2x12 Boutique R121	75	1x8 Champlier Mix	120	1x12 Roamer Mix	164	4x12 Citrus 160 C
31	2x12 Doubleshov (RW)	76	1x8 Vibrato Champlier Mix	121	1x12 Triptik Mix	165	4x12 Citrus 57 C
32	4x10 Bassguy M160	77	1x10 Prince Tone Black Mix	122	2x12 Class-A Mix	166	4x12 Rumble L 121 A
33	4x10 Bassguy P10 (RW)	78	1x10 Prince Tone Silver Mix	123	2x12 Double Verb Mix	167	4x12 Rumble L 4047 A
34	4x12 Basketweave G12H30 (RW)	79	1x12 Junior Blues M160	124	4x12 5153 Mix #1	168	4x12 Rumble L G44 A
35	4x12 Basketweave G12L (RW)	80	1x12 Deluxe Verb Mix	125	4x12 5153 Mix #2	169	4x12 Rumble S 121 C
36	4x12 Basketweave G12M20 (RW)	81	1x12 Deluxe Tweed Mix	126	4x12 Citrus Mix	170	4x12 Rumble S 4047 B
37	4x12 Basketweave G12M25 (RW)	82	1x12 Vibrato Lux Mix	127	4x12 Lerxst R121	171	4x12 Rumble S R1 D
38	4x12 1960A G12M (RW)	83	1x12 Class-A 15w Blue Mix	128	4x12 Cali Mix	172	4x12 Recto 121 C
39	4x12 1960B T75 (RW)	84	1x12 Division 13 Mix	129	4x12 Recto Mix	173	4x12 Recto 4047 E
40	4x12 1960B K120 (RW)	85	1x12 Hot Kitty Mix	130	4x12 Recto New Mix	174	4x12 Recto 57 B
41	4x12 1960B V30 (RW)	86	1x12 Hawaii Mix	131	4x12 TV Mix #1	175	4x12 TV 160 B
42	4x12 Hi-Power (RW)	87	1x15 Tweed Pro Mix	132	4x12 TV Mix #2	176	4x12 TV 57 D
43	4x12 Recto SM57	88	1x15 Empire Mix	133	1x8 EC Champlifier I5	177	4x12 USA 121 B
44	4x12 Recto M160	89	2x10 Super Tweed Mix	134	1x12 Tweed-Verb R121	178	4x12 USA 4047 B
45	4x12 Solo V12 (RW)	90	2x10 Vibrato Lux Mix			179	4x12 USA 57 A

Red cabs are UltraRes IRs. Blue cabs are UltraRes IRs captured using the Mic+DI technique.

<u>AXE-FX CAB</u>	<u>DESCRIPTION</u>
1	1x6 Oval . . . . . 6" Supro, 6x9 oval speaker used in some early amps (Supro). Combine with a Plexi for some Zep.
2	1x8 Tweed . . . . . Fender Blues Jr. Really thin and cutting for roots blues leads.
3	<a href="#">1x10 Prince Tone AT4047</a> . . . . . Fender Princeton with Audio-Technica AT4047 mic (Cab Pack 10).
4	<a href="#">1x10 Prince Tone M160</a> . . . . . Fender Princeton with Beyer M160 mic (Cab Pack 10).
5	<a href="#">1x12 Brown M160</a> . . . . . 1962 Fender Brown Face Vibrolux with Beyer M160 mic; the same amp model used on Dire Straits' debut album (Cab Pack 10).
6	<a href="#">1x12 Black SM57</a> . . . . . Fender Black Face Deluxe Reverb with SM57 mic (Cab Pack 10).
7	<a href="#">1x12 G12T R121</a> . . . . . Marshall G12T-75 with Royer 121 mic. Bandmaster head in a 1x12 combo chassis custom made by Andy Fuchs. (Cab Pack 10).
8	1x12 E12L (RW) . . . . . 200w Electro-Voice EVM-12L, housed in a solid mahogany, open-backed cabinet.
9	1x12 Studio . . . . . Mesa Studio 22.
10	1x12 EMI Open Back (JM) . . . . . Far field IR (Eminence).
11	<a href="#">1x12 Bludo Mix</a> . . . . . Dumble dual port closed-back cab with an 8-ohm Blackhawk WGS Alnico speaker, similar in tone to an EVM-12L (Cab Pack 17).
12	<a href="#">1x12 Shiver 121 (BG)</a> . . . . . Dual-port Bogner Shiva cab with a Classic Lead 80 Celestion 16 ohm speaker (Cab Pack 17).
13	1x12 Tweed Blue (RW) . . . . . 1956 Tweed Deluxe narrow panel with replacement Celestion Alnico Blue speaker for brighter tone with more high end sparkle.
14	1x12 Tweed Deluxe (RW) . . . . . 1956 Tweed Deluxe narrow panel with the original Jensen P12R speaker for the purists. Rounder, warmer sound than the Blue.
15	1x12 Brit Blue (RW) . . . . . Celestion Alnico Blue 12", IR of the speaker without a cabinet.
16	1x12 Brit G12H30 (RW) . . . . . Celestion G12H30", IR of the speaker without a cabinet.
17	1x15 Blues . . . . . Peavey Delta Blues.
18	1x15 Thunderbolt (RW) . . . . . Supro Thunderbolt S6420 cabinet with the original 15" Jensen speaker. Probably a Red Wirez IR. Decent low end for a small, open-backed cabinet, a boost around 550Hz that gives it some mid range "honk", and crunchy upper mids.
19	<a href="#">2x12 TX Star M160</a> . . . . . Mesa Lonestar with Beyer M160 mic (Cab Pack 10).
20	<a href="#">2x12 Double Amp KSM313</a> . . . . . Keith Urban's '59 high-power Fender Twin (Cab Pack 15).
21	<a href="#">2x12 Double Verb R121</a> . . . . . Fender Twin Reverb (Cab Pack 15).
22	<a href="#">2x12 Brown Super M160</a> . . . . . Fender Brownface Super (Cab Pack 15).
23	2x12 Blue . . . . . Chicago Jensen P12Q, two classic American 12" speakers with blue labels.
24	2x12 Top Boost Blue (RW) . . . . . Vox AC30 with two Vox labeled Celestion Alnico Blues made in the UK. Chimey Vox goodness.
25	2x12 Top Boost Silver (RW) . . . . . Vox AC30 with two Vox labeled alnico, silver speakers. These are 25 wattish, T1656 frame, Alnico silvers with Pulsonic cones made for the Thomas Organ Company in the 60's. Slightly less extended upper mids than the blues, same cones as the early greenbacks. Cool speakers in pristine condition.
26	2x12 Boutique (RW) . . . . . Matchless ES212, with one custom voiced 30w Celestion G12H and one 25w Celestion G12M.
27	<a href="#">2x12 Fuzzbomb M160</a> . . . . . Earcandy Buzzbomb with Jensen "Green Machines" (Cab Pack 10).
28	2x12 Gold 30 Far-Field (JM) . . . . . Far field IR of a Celestion Alnico Gold.
29	2x12 G12-65 Far-Field (JM) . . . . . Far field IR of a Celestion G12-65.
30	<a href="#">2x12 Boutique R121</a> . . . . . Matchless DC30 (Cab Pack 10).
31	2x12 Doubleshow (RW) . . . . . Fender Dual Showman cabinet with vintage JBL D130s.
32	<a href="#">4x10 Bassguy M160</a> . . . . . Fender Bassman with Beyer M160 mic (Cab Pack 10).
33	4x10 Bassguy P10 (RW) . . . . . Reproduction Narrow Panel Tweed Bassman cabinet with vintage '57 Jensen P10Qs. Crunchy upper mids, scooped low mids, and tons of low end below 70Hz.
34	4x12 Basketweave G12H30 (RW) . . . . . 68 Marshall Basketweave with a matched quad of vintage, 30w, Celestion G12H "blackbacks." T1281 frames and "444", 55Hz bass cones from the late 70's. Unleash your inner Jimi, or Jimmy, if you prefer.
35	4x12 Basketweave G12L (RW) . . . . . 68 Marshall Basketweave with vintage Celestion G12Ls.
36	4x12 Basketweave G12M20 (RW) . . . . . 68 Marshall Basketweave with 20w Celestion Heritage G12Ms. Brown sound all around.
37	<a href="#">4x12 Basketweave G12M25 (RW)</a> . . . . . 68 Marshall Basketweave with vintage Marshall labeled 25w Celestion G12Ms. These beauties have T1221 frames and Pulsonic 003 "lead" cones.
38	4x12 1960A G12M (RW) . . . . . Slant Marshall 1960 with four 25w Celestion G12Ms, aka "Greenbacks".
39	4x12 1960B T75 (RW) . . . . . Straight Marshall 1960 with four Celestion G12T 75s.
40	4x12 1960B K120 (RW) . . . . . Marshall 1960 cabinet with JBL K120s.
41	4x12 1960B V30 (RW) . . . . . Straight Marshall 1960 with four Celestion Vintage 30s.
42	4x12 Hi-Power (RW) . . . . . 1975 Hiwatt SE4123 cabinet with four vintage 50w Fane purplebacks.

<u>AXE-FX CAB</u>	<u>DESCRIPTION</u>
43 4x12 Recto SM57	Oversized Mesa Rectifier cabinet with four Celestion Vintage 30s.
44 4x12 Recto M160	Mesa Boogie Rectifier with Celestion Vintage 30s.
45 4x12 Solo V12 (RW)	Soldano 412B with four Eminence Legend V12s. A lot more high end than the S12X version. It's a front-loaded cab with lots of resonance so you may need to back the mics off a bit more than usual.
46 4x12 Solo S12X (RW)	Soldano 412B with four Eminence made S12Xs. S12Xs were stock in the older cabs. Give this one a little more distance than you might normally, the cab resonance is pronounced up close and the speakers have a notch in the upper mids between 4-8KHz. Nice for taming fizzy guitars.
47 4x12 German V30 (RW)	Bogner or ENGL Pro cabinet with four Celestion Vintage 30s.
48 4x12 German Boutique	ENGL Pro cabinet with four Celestion Vintage 30s.
49 4x12 PVH6160 (RW)	Older model Peavey 5150 cabinet with four Sheffield 1200 speakers.
50 4x12 Uber T75 (RW)	Bogner Uberkab, with Celestion G12T 75s + Vintage 30s. This IR features the T-75s.
51 4x12 Uber V30 (RW)	Same as above. This IR features the V30s.
52 4x12 Uber T75+V30 (RW)	Same as above. This IR is a 50/50 mix of both speakers.
53 4x12 Citrus V30 (RW)	Straight Orange PPC412 with Celestion Vintage 30s.
54 4x12 Pre-Rola 55 M160 (ML)	Marshall 1935 4x12 cabinet with "pre-Rola" Celestion G12M55 speakers (Cab Pack 20).
55 4x12 Pre-Rola 75 M160 (ML)	Marshall 1960 4x12 cabinet with "pre-Rola" Celestion G12M75 speakers (Cab Pack 20).
56 4x12 Brit 80S R121 (ML)	Marshall 1982A 4x12 cabinet with Rola Celestion G12-80 speakers (Cab Pack 20).
57 4x12 SLM H75 (OH)	SLM Electronics with Scumback H75 speakers, similar to G12.
58 4x12 TV Mix C1 (ML)	Marshall 1960TV Slant Cab with G12M-25 Greenbacks (Cab Pack 8, Cab Pack 20).
59 4x12 TV Mix C4 (ML)	Marshall 1960TV Slant Cab with G12M-25 Greenbacks (Cab Pack 8, Cab Pack 20).
60 4x12 Fractal Gb M160	Mark Day's custom Friedman with Greenbacks, with Beyer M160 mic (Cab Pack 10).
61 4x12 Fractal V30 AT4047	Mark Day's custom Friedman with V30s, with Audio-Technica AT4047 mic (Cab Pack 10).
62 4x12 V30	Generic 4x12 with Celestion V30 speakers.
63 4x12 German	Bogner.
64 4x12 30w (Ultra)	G12H30 from the Axe-Fx Ultra.
65 4x12 Cali	Mesa Boogie traditional.
66 1x15 L.A. Bass	SWR bass amp cabinet.
67 4x10 Aluminum Bass (RW)	Hartke bass cabinet with aluminum drivers.
68 8x10 SV Bass (RW)	Ampeg SVT 810 Bass cab with stock SVT 10" speakers.
69 4x12 Pre-Rola Gb C414	Marshall with Pre-Rola greenbacks (Cab Pack 6).
70 4x12 Beatle Gb	Vox Beatle cabinet with greenbacks (Cab Pack 6).
71 4x12 D120	cabinet with JBL D120s (Cab Pack 6).
72 4x12 Sorcerer	Wizard 4x12 (Cab Pack 6).
73 4x12 USA Trad 57-121 (ML)	Mesa Recto Traditional Straight Cab with V30's (Cab Pack 7).
74 4x12 USA Trad 906-421 (ML)	Mesa Recto Traditional Straight Cab with V30's (Cab Pack 7).
75 1x8 Champlier Mix	Fender Champ with 8" speaker (Producer Pack).
76 1x8 Vibrato Champlier Mix	Fender Vibro Champ with 8" speaker (Producer Pack).
77 1x10 Prince Tone Black Mix	Blackface Fender Princeton with 10" speaker (Producer Pack).
78 1x10 Prince Tone Silver Mix	Silverface Fender Princeton with 10" speaker (Producer Pack).
79 1x12 Junior Blues M160	Fender Blues Junior with Beyer M160 mic (Cab Pack 10).
80 1x12 Deluxe Verb Mix	Fender Deluxe Reverb with 12" speaker (Producer Pack).
81 1x12 Deluxe Tweed Mix	Fender Deluxe Tweed with 12" speaker (Producer Pack).
82 1x12 Vibrato Lux Mix	Fender Vibrolux with 12" speaker (Producer Pack).
83 1x12 Class-A 15w Blue Mix	Vox AC-15 with 12" Alnico Blue (Producer Pack).
84 1x12 Division 13 Mix	Divided By 13 CJ 11 with 12" G12M (Producer Pack).
85 1x12 Hot Kitty Mix	Black Cat Hot Cat 30R with 12" proprietary Celestion speaker (V30) (Producer Pack).
86 1x12 Hawaii Mix	Ohau cabinet (Producer Pack).
87 1x15 Tweed Pro Mix	Fender Pro with 15" speaker (Producer Pack).

<u>AXE-FX CAB</u>	<u>DESCRIPTION</u>
88	1x15 Empire Mix . . . . . 15" Eminence speaker (Producer Pack).
89	2x10 Super Tweed Mix . . . . . Fender Super Reverb with two 10" speakers (Producer Pack).
90	2x10 Vibrato Lux Mix . . . . . Fender Vibrolux with two 10" speakers (Producer Pack).
91	2x12 Double Verb Mix . . . . . Fender Twin Reverb with two 12" speakers (Producer Pack).
92	2x12 Pro Verb Mix . . . . . Fender Pro Reverb with two 12" speakers (Producer Pack).
93	2x12 Class-A 30w Blue Mix . . . . . Vox AC-30 with two 12" Alnico Blue speakers (Producer Pack).
94	2x12 Class-A 30w Silver Mix . . . . . Vox AC-30 with two 12" Alnico Silver speakers (Producer Pack).
95	2x12 Supremo Mix . . . . . Supro with two 12" speakers (Producer Pack).
96	2x12 Santiago EJ1250 . . . . . 12" Eminence EJ1250 50w speaker in a Fender closed-back cabinet (Producer Pack).
97	2x12 Santiago Altec . . . . . 12" Altec 417-8H speaker in a half-open cabinet (Producer Pack).
98	3x10 Vibrato King Mix . . . . . Fender Vibro-King with three 10" speakers (Producer Pack).
99	4x10 Bassguy Mix . . . . . Fender Bassman with four 10" speakers (Producer Pack).
100	4x10 Super Verb Mix . . . . . Fender Super Reverb with four 10" speakers (Producer Pack).
101	4x12 Basketweave Green Mix . . . . . Marshall cabinet with four 12" G12M (greenback) speakers (Producer Pack).
102	4x12 Basketweave AX Mix . . . . . Marshall 1960AX (angled front) with four 12" (probably greenbacks) speakers (Producer Pack).
103	4x12 Basketweave TV Mix . . . . . Marshall 1960TV angled tall cabinet with four 12" (probably greenbacks) speakers (Producer Pack).
104	4x12 Cali Lead 80s Mix . . . . . Mesa cabinet from the 80s with four Classic Lead 80 speakers (Cab Pack 14).
105	4x12 Rumble EV12L RNR1 . . . . . EVM 12L speakers in a 12L/12S "Thiele" Dumble cabinet (Cab Pack 17).
106	4x12 Rumble EV12S M160 . . . . . EVM 12S speakers in a 12L/12S "Thiele" Dumble cabinet (Cab Pack 17).
107	4x12 PVH6160 Mix . . . . . EVH 5150 cabinet (Producer Pack).
108	4x12 Petrucci V30 Mix . . . . . John Petrucci's Mesa cabinet with V30s (Producer Pack). Adam Cook: "The Petrucci V30 Mix is pretty dark but that is the way he mics his cabs. It's a two mic blend and neither mic is particularly close to the center of the cab."
109	1x15 SV Bass M88 Mix . . . . . bass cabinet, Beyerdynamic M88 microphone (Producer Pack).
110	1x15 SV Bass Subkick Mix . . . . . bass cabinet, subkick (Producer Pack).
111	4x10 SV Bass M88 Mix . . . . . bass cabinet, Beyerdynamic M88 microphone (Producer Pack).
112	4x10 SV Bass Subkick Mix . . . . . bass cabinet, subkick (Producer Pack).
113	4x10+Tweeter SV Bass M88 Mix . . . . . bass cabinet, M88 microphone (Producer Pack).
114	1x12 Class-A 20 Dlx Mix . . . . . Morgan AC20 Deluxe cabinet (Producer Pack).
115	1x12 Nuclear Tone Mix . . . . . Swart Atomic Space Tone cabinet, open back, Mojotone British Vintage Series BV-25m speaker (Cab Pack 10).
116	1x12 Scumtone 25W Mix . . . . . Cas Azera Tone-Tools detuned cabinet with Scumback H55 (Producer Pack).
117	2x12 Boutique Mix . . . . . Matchless cabinet (Producer Pack).
118	2x12 SV Legend Mix . . . . . Carvin Legacy cabinet, closed back (Producer Pack).
119	1x12 AC-20 Dlx Mix . . . . . Morgan AC20 Deluxe cabinet (Cab Pack 4).
120	1x12 Roamer Mix . . . . . Carr Roamer cabinet (Cab Pack 4).
121	1x12 Triptik Mix . . . . . Carol-Ann Triptik cabinet with Scholz Classic speaker (Cab Pack 5, Cab Pack 14).
122	2x12 Class-A Mix . . . . . Vox AC-30 cabinet (Cab Pack 4).
123	2x12 Double Verb Mix . . . . . Fender Twin Reverb cabinet (Cab Pack 4).
124	4x12 5153 Mix #1 . . . . . EVH 5150 III cabinet (Cab Pack 5, Cab Pack 14).
125	4x12 5153 Mix #2 . . . . . EVH 5150 III cabinet (Cab Pack 5, Cab Pack 14).
126	4x12 Citrus Mix . . . . . Orange cabinet with V30s (Cab Pack 5, Cab Pack 14).
127	4x12 Lerxst R121 . . . . . Mojotone Lerxst ported cabinet with greenbacks, works well with Marshall Silver Jubilee (Cab Pack 14).
128	4x12 Cali Mix . . . . . Mesa cabinet with Classic Lead 80 speakers (Cab Pack 5, Cab Pack 14).
129	4x12 Recto Mix . . . . . Mesa Rectifier vintage cabinet (Cab Pack 5, Cab Pack 14).
130	4x12 Recto New Mix . . . . . Mesa Rectifier standard cabinet (Cab Pack 5, Cab Pack 14).
131	4x12 TV Mix #1 . . . . . early 70's Marshall 1960 TV angled tall cabinet with four 12" speakers (Cab Pack 5, Cab Pack 14).
132	4x12 TV Mix #2 . . . . . early 70's Marshall 1960 TV angled tall cabinet with four 12" speakers (Cab Pack 5, Cab Pack 14).

<u>AXE-FX CAB (XL-ONLY)</u>	<u>DESCRIPTION</u>
133 1x8 EC Champfier I5	Fender Champ.
134 1x12 Tweed-Verb R121	Fender Deluxe Tweed.
135 1x12 AC-20 Dlx M160	Morgan AC-20 Deluxe.
136 1x12 Roamer R121 Reverse	Carr Roamer cabinet, Royer 121 (Cab Pack 4).
137 2x12 Double Verb M160	Fender Twin Reverb.
138 2x12 Class-A Blues Mix	Vox AC-30 with two 12" Blue Alnico speakers.
139 4x12 Cali Lead 80S M160	Mesa cabinet with Classic Lead 80 speakers, M160 microphone (Cab Pack 14).
140 1x12 Dlx Aln-Slv Mix (OH)	MojoTone Narrow Panel Deluxe open back cabinet, with one 12" Silver Alnico speaker (Cab Pack 3).
141 1x12 Dlx Fn-42 Mix (OH)	MojoTone Narrow Panel Deluxe open back cabinet, with one 12" Fane speaker.
142 1x12 Dlx J12-Pr Mix (OH)	MojoTone Narrow Panel Deluxe open back cabinet, with one 12" Jensen J12 speaker.
143 2x12 Bog-Sh Fn-42 Mix (OH)	Bogner Shiva open back cabinet, with two 12" Fane speakers.
144 4x12 Mar-Cb EV-S Mix (OH)	Marshall cabinet with EVM 12S speakers.
145 4x12 Mar-Cb Fn-42 Mix (OH)	Marshall cabinet with two 12" Fane speakers.
146 4x12 Mar-Cb H-Pr-55 Mix (OH)	Marshall cabinet, with four 12" Pre-Rola G12H30 speakers.
147 4x12 Mar-Cb M-BB-55 Mix (OH)	Marshall cabinet, with 4 12" Pre-Rola black back G12M speakers.
148 4x12 Mar-Cb Sb-75 Mix (OH)	Marshall cabinet, with 4 12" Scumback M75 speakers.
149 4x12 Mar-Cb V30-Ch Mix (OH)	Marshall cabinet, with 4 Chinese 12" V30 speakers.
150 1x12 Shadow Mix (TAF)	Mesa Lonestar cabinet with C90 speaker.
151 1x12 Vintage Mars Mix (TAF)	Marshall cabinet with G12M speaker.
152 2x10 Fen Room Mix (TAF)	'59 Fender cabinet with Jensen speakers.
153 2x12 Art+Tango Jr Mix (TAF)	mix of a Black Star Artisan G12H and Orange V30.
154 2x12 Acrox Mix (TAF)	Vox AC-30 with two 12" Blue Alnico speakers.
155 4x12 Wat Mix (TAF)	Hiwatt with four Fane speakers.
156 4x12 Starfound Mix (TAF)	WEM Starfinder with four custom Fane speakers.
157 4x12 G12T Mix (TAF)	Marshall cabinet with G12T-75 speakers.
158 4x12 Mars Bw G12 Room Mix (TAF)	Marshall Basketweave with Pre-Rola G12M speakers.
159 4x12 Vintmars+Bw Room Mix (TAF)	Mix of G12M speakers in Marshall cabinets.
160 4x12 5153 121 G	4x12 EVH 5150 III cabinet, Royer 121 (Cab Pack 14).
161 4x12 5153 4047 G	4x12 EVH 5150 III cabinet, Audio-Technica AT4047 (Cab Pack 14).
162 4x12 5153 57 C	4x12 EVH 5150 III cabinet, Shure SM57 (Cab Pack 14).
163 4x12 Citrus 121 B	4x12 Orange PPC412 cabinet, Royer 121 (Cab Pack 14).
164 4x12 Citrus 160 C	4x12 Orange PPC412 cabinet, Beyer 160 (Cab Pack 14).
165 4x12 Citrus 57 C	4x12 Orange PPC412 cabinet, Shure SM57 (Cab Pack 14).
166 4x12 Rumble L 121 A	EVM 12L speakers in a 4x12 12L/12S "Thiele" Dumble cabinet, Royer 121 (Cab Pack 17).
167 4x12 Rumble L 4047 A	EVM 12L speakers in a 4x12 12L/12S "Thiele" Dumble cabinet, Audio-Technica AT-4047 (Cab Pack 17).
168 4x12 Rumble L G44 A	EVM 12L speakers in a 4x12 12L/12S "Thiele" Dumble cabinet (Cab Pack 17).
169 4x12 Rumble S 121 C	EVM 12S speakers in a 4x12 12L/12S "Thiele" Dumble cabinet, Royer 121 (Cab Pack 17).
170 4x12 Rumble S 4047 B	EVM 12S speakers in a 4x12 12L/12S "Thiele" Dumble cabinet, Audio-Technica AT-404 (Cab Pack 17).
171 4x12 Rumble S R1 D	EVM 12S speakers in a 4x12 12L/12S "Thiele" Dumble cabinet, SE Electronics RNR1 (Cab Pack 17).
172 4x12 Recto 121 C	Mesa 4x12 Rectifier cabinet, Royer 121 (Cab Pack 14).
173 4x12 Recto 4047 E	Mesa 4x12 Rectifier cabinet, Audio-Technica AT-4047 (Cab Pack 14).
174 4x12 Recto 57 B	Mesa 4x12 Rectifier cabinet, Shure SM57 (Cab Pack 14).
175 4x12 TV 160 B	Marshall 4x12 TV (Tall Vertical) angled cabinet, G12M speakers, Beyer 160 (Cab Pack 14).
176 4x12 TV 57 D	Marshall 4x12 TV (Tall Vertical) angled cabinet, G12M speakers, Shure SM57 (Cab Pack 14).
177 4x12 USA 121 B	Mesa 4x12 cabinet, Royer 121 (Cab Pack 14).
178 4x12 USA 4047 B	Mesa 4x12 cabinet, Audio-Technica AT-4047 (Cab Pack 14).
179 4x12 USA 57 A	Mesa 4x12 cabinet, Shure SM57 (Cab Pack 14).

<u>AXE-FX AMP</u>	<u>SPEAKER TYPE</u>
1959SLP .....	G12M, G12H, G12L
1987x.....	G12M, G12H, G12L
5153.....	G12-EVH (G12H30)
59/65 Bassguy .....	4x10, 2x12
5F1 Tweed .....	8" speakers
5F8 Tweed .....	Jensen P12
6G12 Concert .....	4x10 Jensen P10R, P10Q, C10R
6G4 Super .....	2x10 Jensen P10R, P10Q, Oxford 10K5
AC-20 Dlx.....	Alnico Blue, G12H, Greenback
Angle Severe .....	V30
Atomica .....	G12H
Band-Commander .....	2x12 (Jensen C12N)
Blanknshp Leeds.....	2x10 Jensen C10Q, Alnico Blue
Bludojai .....	G12-65, EVM 12L
Boutique .....	G12M + G12H
Brit 800/Silver.....	G12M, G12H, V30, T75
Brit AFS100/Super .....	V30
Brit Brown .....	G12M, G12H, EVH
Brit JM45 .....	G12M, G12H, G12L
Brit JVM .....	V30 + G12H
Brit Pre .....	(preamp)
Buttery .....	G12M, G12H
CA OD-2.....	EVM 12L or Celestion Classic Lead 80
CA Tucana .....	G12-65, V30, G12-75
CA3+ .....	(preamp)
Cali Leggy .....	V30
Cameron .....	G12H
Car Roamer .....	12" Eminence Elsinore
Citrus A30, Terrier .....	G12H
Citrus RV50 .....	V30
Class-A 15w/30w.....	Alnico Blue, G12M
Comet .....	Greenbacks, G12H, V30
Corncob M50 .....	60w V30
Das Metall .....	V30, G12K100
Deluxe Tweed.....	Jensen P12R, C12N, Alnico Blue
Deluxe Verb.....	1x12 (Jensen C12Q, EVM 12L, JBL D120), 2x10 (Jensen C10N, C10Q, P10R)
Dirty Shirley .....	V30, G12M, G12H
Div/13 CJ .....	G12M
Div/13 FT37.....	Alnico Blue + G12H30
Dizzy V4 .....	V30, G12K100
Double Verb .....	2x12 (Jensen C12N, JBL D120, EVM-12L)
Energyball .....	V30, custom V60

<u>AXE-FX AMP</u>	<u>SPEAKER TYPE</u>
Euro Blue/Red .....	V30
Euro Uber.....	V30 + G12T75 (Uberkab)
Fox ODS .....	G12-65, EVM 12L
Friedman .....	G12M, G12H, V30
Fryette D60 .....	Eminence P50E
Gibtone Scout .....	1x10
Herbie .....	V30, G12K100
HiPower .....	4x12 Fane
Hot Kitty.....	Bad Cat proprietary Celestion
Jazz 120 .....	2x12 "silver" Roland
JR Blues.....	Jensen C12N, P12R
JS410.....	G12T-75, Greenback, G12-H30
Matchbox D-30 .....	G12H30 + G12M
Mr Z Hwy 66.....	V30 + G12H
Mr Z MZ-38, MZ-8.....	G12H
Nuclear-Tone .....	G12M
ODS-100.....	G12-65, EVM 12L
Plexi.....	G12M, G12H, G12L
Prince Tone .....	Jensen C10N
PVH 6160.....	Sheffield 1200
Recto.....	V30
Ruby Rocket .....	Alnico
Shiver .....	V30, G12M
Solo 88 .....	(preamp)
Solo 99 .....	(preamp)
Solo 100.....	12" Eminence
Spawn.....	G12M, G12-65, V30
Suhr Badger .....	V30
Super Verb.....	4x10 Jensen C10R, C10Q, P10R
Supremo Trem .....	6" oval speaker, 12" or 15" Jensen
SV Bass .....	8x10
Tremolo Lux .....	2x10
Tube Pre.....	(preamp)
Two-Stone J35 .....	G12-65
TX Star Lead .....	Mesa C90 (a modified CL80)
USA IIC+ .....	EVM 12L
USA Pre.....	(preamp)
USA Sub Blues .....	10" Eminence Black Shadow
USA (all others) .....	Mesa C90 (a modified CL80)
Vibra-King .....	3x10
Vibrato Lux .....	2x10 (Jensen C10Q), Oxford 1x12
Vibrato Verb .....	1x15 (Jensen C15N, JBL D130, Eminence), 2x10 (Jensen C10Q)
Wrecker .....	G12M

ULTRA-RES IRS GROUPED BY CAB/SPEAKER TYPE

<u>CAB TYPE</u>	<u>FACTORY CAB</u>	<u>SPEAKER TYPE</u>	<u>FACTORY CAB</u>
5150 4x.....	124, 125, 160-162	Alnico .....	11, 138, 140, 154
Bogner 1x .....	12	Altec 417-8H.....	97
Bogner 2x .....	143	C90.....	150
Carol-Ann 1x.....	121	Classic Lead 80.....	12, 104, 128, 139
Car Roamer 1x .....	120, 136	Eminence EJ1250 .....	96
Dumble 1x.....	11	EVM-12L.....	11, 105, 166-168
Dumble 4x.....	105, 106, 166-171	EVM-12S.....	106, 144, 169-171
Earcandy 2x.....	27	Fane.....	141, 143, 145, 155, 156
Fender 1x.....	3, 4, 5, 6, 79, 133, 134	G12-80 .....	56
Fender 2x.....	20, 21, 22, 96, 123, 137, 152	G12H-30.....	146
Fender 4x.....	32	G12M-25/Greenback...	37, 58-60, 69, 70, 127, 151, 158, 159, 175, 176
Friedman 4x .....	60, 61	G12M-55 .....	54, 147
Hiwatt 4x .....	155, 156	G12M-75 .....	55
Marshall 1x .....	151	G12T-75 .....	7, 157
Marshall 4x .....	37, 54-56, 58, 59, 69, 131, 132, 144-149, 157-159, 175, 176	JBL-D120 .....	71
Matchless 2x.....	30	Jensen.....	27, 142, 152
Mesa 1x .....	150	Mojotone BV-25m.....	115
Mesa 2x .....	19	Scumback M75 .....	148
Mesa 4x .....	43, 44, 73, 74, 104, 128, 129, 130, 139, 172-174, 177-179	V30.....	43, 44, 61, 73, 74, 126, 149
Mojotone 1x.....	140-142		
Mojotone 4x.....	127		
Morgan 1x.....	119, 135		
Orange 4x .....	126, 163-165		
Swart 1x.....	115		
Vox 2x.....	122, 138, 154		
Vox 4x.....	70		
Wizard 4x.....	72		

## Understanding All the Different Gain Controls

The amp block in the Axe-Fx has a variety of gain controls that change depending upon the amp model selected. These controls are:

Input Drive

Input Trim

Overdrive

Master Volume

These various controls are located at fixed points in the virtual amplifier circuit as follows:

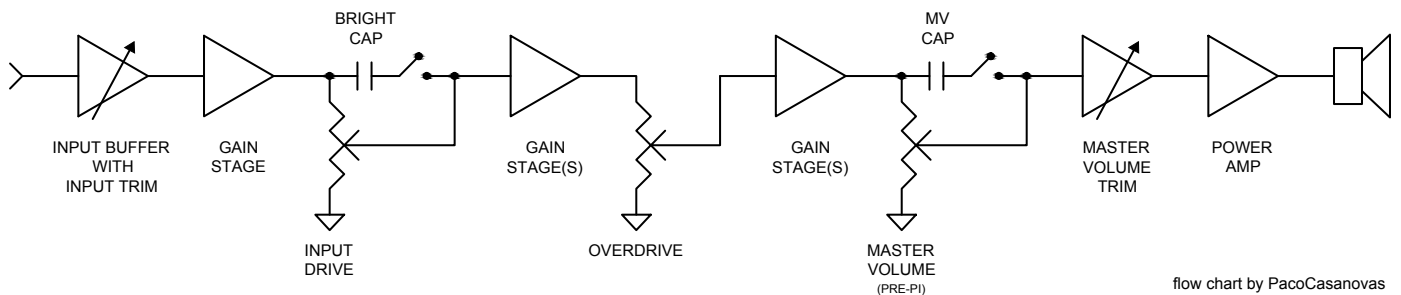

### Input Drive

This is the modeled amp's gain, drive, volume, etc. control. It adjusts the attenuation at the input to the amplifier gain stages after the input buffer. On a Marshall Plexi, for example, it is the "Loudness" control. On a typical Fender amp it is the "Volume" control. On many high-gain amps it is called either "Gain" or "Drive".

On a real amp this is implemented using a variable resistor (potentiometer). Many amps include a "bright cap" on the drive control which is a small value capacitor placed across the terminals of the pot that bleeds treble frequencies through as the gain is reduced. Sometimes this bright cap is switchable via a switch on the amp. Sometimes it is fixed.

### Input Trim

The Input Trim control adjusts the input attenuation without changing the frequency response. If you turn down the Input Drive and the model has a bright cap the amp will get brighter. Now you may like the brighter tone but wish there were more gain. Input Trim allows you to increase the gain without changing the tone. Conversely you may like the darker tone with Input Drive set high but wish there were less gain. In this case you can lower Input Trim.

Most real amps do not possess an Input Trim control. Instead they usually have a switch or two input jacks that select between a high-gain and low-gain input. Almost invariably the difference between these two jacks is 6 dB. All the Axe-Fx amps are modeled using the high-gain input or switch position (if any). To simulate the low-gain input set the Input Trim to 0.5 which is 6 dB less.

### Overdrive

Some amps possess an attenuation control between the later gain stages. Examples of the are the Mesa/Boogie Mark series, Dumble ODS and others. This control allows the user to vary the gain staging. The Input Drive can be turned up and the Overdrive turned down so that the earlier stages distort more and the later stages distort less and vice-versa.

### Master Volume

The Master Volume (MV) controls how much signal level is sent to the power amp. Many vintage amps have no MV control and the power amp runs "wide open". Modern amps often get their distortion from the preamp and the Master Volume then allows the user to control the volume of the amp.

The Master Volume in the Axe-Fx II, as well as on real amps, is probably the singular most powerful control in the amp block. As the Master Volume is increased the virtual power amp begins to distort. The virtual power amp also begins to sag and all sorts of beautiful magic occurs. The tone becomes more focused, the dynamic response changes, the note attack is accentuated, etc.

The key to crafting the ultimate tone involves understanding these controls and learning how to balance them.



<u>DRIVE BLOCK</u>	<u>DESCRIPTION</u>
BB Pre *	Xotic BB Preamp
Bender Fuzz	classic Tonebender circuit
Bit Crusher	a black box we found lying in the trash outside Studio Harshclip
Blues OD	Marshall Bluesbreaker
Esoteric ACB	Xotic AC Booster
Esoteric RCB	Xotic RC Booster
Eternal Love *	Lovepedal Eternity
Face Fuzz	Dallas Arbiter Fuzz Face
FAS Boost	Cleanish boost great for boosting vintage amps like Plexis
FAS LED-Drive *	LED diodes have a higher voltage drop than silicon diodes
Fat Rat	modified Pro Co RAT, a bit fuller and smoother
FET Boost	gentle, smooth, clipping booster with tone controls
FET Preamp	Boss FA-1, a JFET preamp pedal (used by The Edge)
Full OD *	Fulltone Fulldrive
Hard Fuzz	hard-clipping, 60s-style fuzz
M-Zone Dist	Boss MT-2 Metal Zone, popular for extreme gain settings
Master Fuzz	Gibson Maestro Fuzz Tone FZ-1A, aka Satisfaction fuzz
Micro Boost	MXR Micro Amp
Mid Boost	custom FAS mid boost
Octave Dist	Tycobrahe Octavia
PI Fuzz	Big Muff Pi Fuzz
Plus Dist	MXR Distortion +
Rat Dist	Pro Co RAT
Ruckus	Suhr Riot
SDD Preamp	preamp in Korg's SDD-3000 digital delay (used by The Edge)
Shred Dist	Marshall ShredMaster
Super OD *	Boss SD-1 Super OverDrive
T808 Mod *	Ibanez TS9, captures the most popular Tubescreamer mods
T808 OD *	Ibanez TS9 Tube Screamer (used by SRV)
Tape Dist	simulates the clipping of an overdriven reel-to-reel tape deck
Treble Boost	Dallas Rangemaster
Tube Drv 3-Knob	Chandler/Butler Tube Driver with a 12AX7, 3-knob version
Tube Drv 4-knob	4-knob version
Zen Master *	Hermida/Lovepedal Zendrive (used by Robben Ford)

\* based on the Tube Screamer

### **Cliff's Workflow**

- 1) Pick an amp and set everything to default settings.
- 2) Select a cab IR that is compatible with the amp (1x12, 2x12, etc.)
- 3) Choose an IR with an R121 or M160 as these have the best low end.
- 4) Change the cab block to stereo and find a complementary IR from the same cab to get the desired brilliance, usually an SM57 or 4047.
- 5) Go back to the amp block and dial it in.

## CC ASSIGNMENTS

sorted by function

<u>Function</u>	<u>CC</u>	<u>Function</u>	<u>CC</u>	<u>Function</u>	<u>CC</u>
Amp 1 Bypass	37	Filter 2 Bypass	53	Phaser 2 X/Y	113
Amp 1 X/Y	100	Filter 3 Bypass	54	Pitch 1 Bypass	77
Amp 2 Bypass	38	Filter 4 Bypass	55	Pitch 1 X/Y	114
Amp 2 X/Y	101	Flanger 1 Bypass	56	Pitch 2 Bypass	78
Bypass	13	Flanger 1 X/Y	110	Pitch 2 X/Y	115
Cab 1 Bypass	39	Flanger 2 Bypass	57	Quad Chorus 1 Bypass	79
Cab 1 X/Y	102	Flanger 2 X/Y	111	Quad Chorus 2 Bypass	80
Cab 2 Bypass	40	Formant 1 Bypass	58	Resonator 1 Bypass	81
Cab 2 X/Y	103	FX Loop Bypass	59	Resonator 2 Bypass	82
Chorus 1 Bypass	41	Gate/Expander 1 Bypass	60	Reverb 1 Bypass	83
Chorus 1 X/Y	104	Gate/Expander 2 Bypass	61	Reverb 1 X/Y	116
Chorus 2 Bypass	42	Graphic EQ 1 Bypass	62	Reverb 2 Bypass	84
Chorus 2 X/Y	105	Graphic EQ 2 Bypass	63	Reverb 2 X/Y	117
Compressor 1 Bypass	43	Graphic EQ 3 Bypass	64	Ring Modulator Bypass	85
Compressor 2 Bypass	44	Graphic EQ 4 Bypass	65	Rotary 1 Bypass	86
Crossover 1 Bypass	45	Input Volume	10	Rotary 1 X/Y	125
Crossover 2 Bypass	46	Looper Bypass	33	Rotary 2 Bypass	87
Delay 1 Bypass	47	Looper Dub	31	Rotary 2 X/Y	126
Delay 1 X/Y	106	Looper Half	120	Scene Increment	123
Delay 2 Bypass	48	Looper Once	30	Scene Decrement	124
Delay 2 X/Y	107	Looper Play	29	Scene Select	34
Drive 1 Bypass	49	Looper Record	28	Synth 1 Bypass	88
Drive 1 X/Y	108	Looper Rev	32	Synth 2 Bypass	89
Drive 2 Bypass	50	Looper Undo	121	Tempo	14
Drive 2 X/Y	109	Megatap Delay Bypass	66	Tone Matching	99
Enhancer Bypass	51	Metronome	122	Tremolo/Panner 1 Bypass	90
External Control 1	16	Multiband Comp 1 Bypass	67	Tremolo/Panner 2 Bypass	91
External Control 2	17	Multiband Comp 2 Bypass	68	Tuner	15
External Control 3	18	Multi Delay 1 Bypass	69	Vocoder Bypass	92
External Control 4	19	Multi Delay 2 Bypass	70	Volume Decrement	36
External Control 5	20	Out 1 Volume	11	Volume Increment	35
External Control 6	21	Out 2 Volume	12	Volume/Pan 1 Bypass	93
External Control 7	22	Parametric EQ 1 Bypass	71	Volume/Pan 2 Bypass	94
External Control 8	23	Parametric EQ 2 Bypass	72	Volume/Pan 3 Bypass	95
External Control 9	24	Parametric EQ 3 Bypass	73	Volume/Pan 4 Bypass	96
External Control 10	25	Parametric EQ 4 Bypass	74	Wahwah 1 Bypass	97
External Control 11	26	Phaser 1 Bypass	75	Wahwah 1 X/Y	118
External Control 12	27	Phaser 1 X/Y	112	Wahwah 2 Bypass	98
Filter 1 Bypass	52	Phaser 2 Bypass	76	Wahwah 2 X/Y	119

## CC ASSIGNMENTS

sorted by CC

<u>Function</u>	<u>CC</u>	<u>Function</u>	<u>CC</u>	<u>Function</u>	<u>CC</u>
Input Volume . . . . .	10	Drive 1 Bypass . . . . .	49	Synth 1 Bypass . . . . .	88
Out 1 Volume . . . . .	11	Drive 2 Bypass . . . . .	50	Synth 2 Bypass . . . . .	89
Out 2 Volume . . . . .	12	Enhancer Bypass . . . . .	51	Tremolo/Panner 1 Bypass . . .	90
Bypass . . . . .	13	Filter 1 Bypass . . . . .	52	Tremolo/Panner 2 Bypass . . .	91
Tempo Tap . . . . .	14	Filter 2 Bypass . . . . .	53	Vocoder Bypass . . . . .	92
Tuner . . . . .	15	Filter 3 Bypass . . . . .	54	Volume/Pan 1 Bypass . . . . .	93
External Control 1 . . . . .	16	Filter 4 Bypass . . . . .	55	Volume/Pan 2 Bypass . . . . .	94
External Control 2 . . . . .	17	Flanger 1 Bypass . . . . .	56	Volume/Pan 3 Bypass . . . . .	95
External Control 3 . . . . .	18	Flanger 2 Bypass . . . . .	57	Volume/Pan 4 Bypass . . . . .	96
External Control 4 . . . . .	19	Formant 1 Bypass . . . . .	58	Wahwah 1 Bypass . . . . .	97
External Control 5 . . . . .	20	FX Loop Bypass . . . . .	59	Wahwah 2 Bypass . . . . .	98
External Control 6 . . . . .	21	Gate/Expander 1 Bypass . . . .	60	Tone Matching . . . . .	99
External Control 7 . . . . .	22	Gate/Expander 2 Bypass . . . .	61	Amp 1 X/Y . . . . .	100
External Control 8 . . . . .	23	Graphic EQ 1 Bypass . . . . .	62	Amp 2 X/Y . . . . .	101
External Control 9 . . . . .	24	Graphic EQ 2 Bypass . . . . .	63	Cab 1 X/Y . . . . .	102
External Control 10 . . . . .	25	Graphic EQ 3 Bypass . . . . .	64	Cab 2 X/Y . . . . .	103
External Control 11 . . . . .	26	Graphic EQ 4 Bypass . . . . .	65	Chorus 1 X/Y . . . . .	104
External Control 12 . . . . .	27	Megatap Delay Bypass . . . . .	66	Chorus 2 X/Y . . . . .	105
Looper Record . . . . .	28	Multiband Comp 1 Bypass . . . .	67	Delay 1 X/Y . . . . .	106
Looper Play . . . . .	29	Multiband Comp 2 Bypass . . . .	68	Delay 2 X/Y . . . . .	107
Looper Once . . . . .	30	Multi Delay 1 Bypass . . . . .	69	Drive 1 X/Y . . . . .	108
Looper Dub . . . . .	31	Multi Delay 2 Bypass . . . . .	70	Drive 2 X/Y . . . . .	109
Looper Rev . . . . .	32	Parametric EQ 1 Bypass . . . . .	71	Flanger 1 X/Y . . . . .	110
Looper Bypass . . . . .	33	Parametric EQ 2 Bypass . . . . .	72	Flanger 2 X/Y . . . . .	111
Scene Select . . . . .	34	Parametric EQ 3 Bypass . . . . .	73	Phaser 1 X/Y . . . . .	112
Volume Increment . . . . .	35	Parametric EQ 4 Bypass . . . . .	74	Phaser 2 X/Y . . . . .	113
Volume Decrement . . . . .	36	Phaser 1 Bypass . . . . .	75	Pitch 1 X/Y . . . . .	114
Amp 1 Bypass . . . . .	37	Phaser 2 Bypass . . . . .	76	Pitch 2 X/Y . . . . .	115
Amp 2 Bypass . . . . .	38	Pitch 1 Bypass . . . . .	77	Reverb 1 X/Y . . . . .	116
Cab 1 Bypass . . . . .	39	Pitch 2 Bypass . . . . .	78	Reverb 2 X/Y . . . . .	117
Cab 2 Bypass . . . . .	40	Quad Chorus 1 Bypass . . . . .	79	Wahwah 1 X/Y . . . . .	118
Chorus 1 Bypass . . . . .	41	Quad Chorus 2 Bypass . . . . .	80	Wahwah 2 X/Y . . . . .	119
Chorus 2 Bypass . . . . .	42	Resonator 1 Bypass . . . . .	81	Looper Half . . . . .	120
Compressor 1 Bypass . . . . .	43	Resonator 2 Bypass . . . . .	82	Looper Undo . . . . .	121
Compressor 2 Bypass . . . . .	44	Reverb 1 Bypass . . . . .	83	Metronome . . . . .	122
Crossover 1 Bypass . . . . .	45	Reverb 2 Bypass . . . . .	84	Scene Increment . . . . .	123
Crossover 2 Bypass . . . . .	46	Ring Modulator Bypass . . . . .	85	Scene Decrement . . . . .	124
Delay 1 Bypass . . . . .	47	Rotary 1 Bypass . . . . .	86	Rotary 1 X/Y . . . . .	125
Delay 2 Bypass . . . . .	48	Rotary 2 Bypass . . . . .	87	Rotary 2 X/Y . . . . .	126

EVH 5150 III 100w AMP  
recommended settings from the manual  
red dots indicate Eddie's personal settings

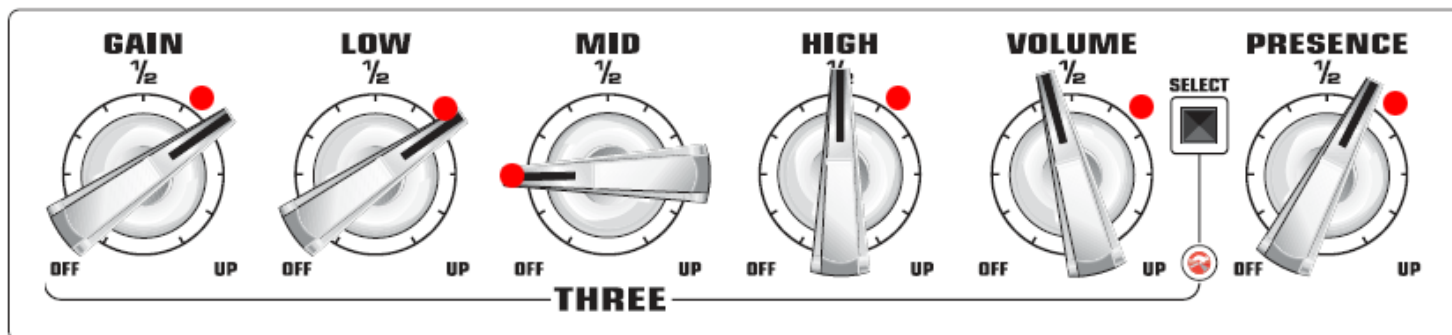
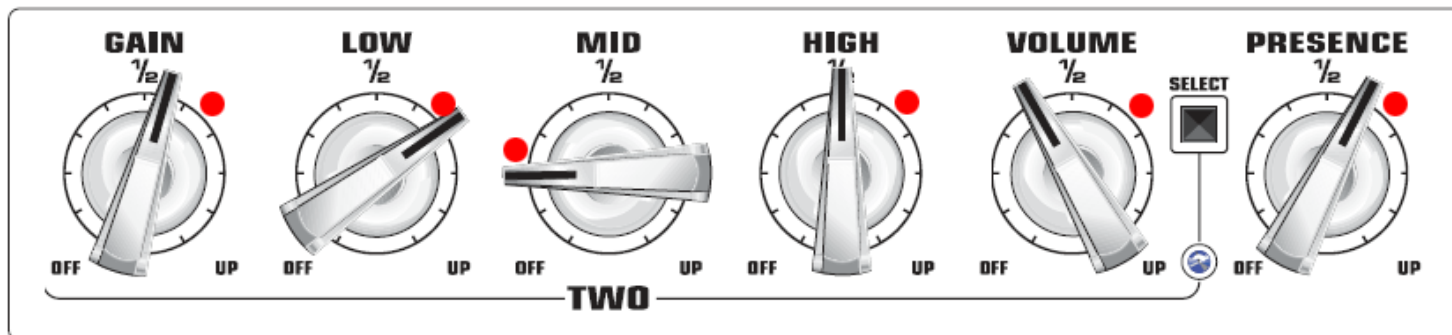
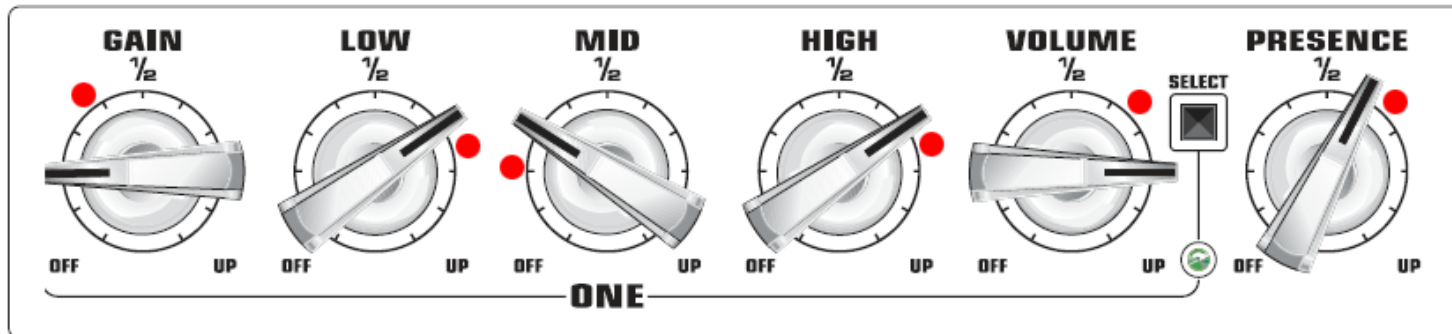

## REVISION HISTORY

Red text in a parameter description indicates a new function not yet accessible in Axe-Edit.

2016-08-18 – Firmware Quantum 4.00 update.

2016-06-07 – Firmware Quantum 3.03 update.

2016-04-25 – Firmware Quantum 3.01 update, Axe-Edit 3.7.0 update. New parameter: "XFormer Grind".

2016-03-22 – Firmware Quantum 2.04 update, Axe-Edit 3.6.1 update. New parameter: "Modeling Version".

2016-03-13 – Firmware Quantum 2.02 update.

2016-03-07 – Firmware Quantum 2.01 update, Axe-Edit 3.6.0 update. New parameter: "Harmonics"; new preamp tube types.

2016-02-05 – Firmware Quantum 2.00 update, Axe-Edit 3.5.0 update. New parameter: "Filter Slope"

2016-01-29 – Firmware Quantum 2.00 beta update. Updated cab list.

2015-12-19 – Firmware Quantum 1.06 update, Axe-Edit 3.4.0 update.

2015-11-29 – Firmware Quantum 1.04 update.

2015-11-26 – Firmware Quantum 1.03 update.

2015-11-18 – Firmware Quantum 1.02 update.

2015-09-17 – Firmware Quantum 1.00 update, Axe-Edit 3.3.0 update. New parameter: "Dephase".

2015-06-21 – Firmware 19.00 update, Axe-Edit 3.2.0 update. New parameters: "Comp Type" and "Comp Clarity". New feature: "Preset-Cab Bundle".

2015-05-04 – Firmware 18.12 update.

2015-04-21 – Firmware 18.08 update, Axe-Edit 3.1.10 update. There are now four preamp tube types.

2015-04-07 – Firmware 18.06 update. Vintage type removed from Preamp Tube Type options.

2015-03-30 – Firmware 18.04 update, Axe-Edit 3.1.9 update. Added XL-only cabs to the cab list. Added UltraRes categories of the factory cabs.

2015-03-25 – Firmware 18.04 beta update.

2015-03-20 – Firmware 18.03 update, Axe-Edit 3.1.7 update. Character parameters reinstated by popular demand.

2015-03-16 – Axe-Edit 3.1.6 update.

2015-03-15 – Firmware 18.01 update.